

FM STEREO/FM-AM RECEIVER

STR-AV1000/900

Operating Instructions

Before operating the unit, please read this manual thoroughly and retain it for future reference.

STR-AV1000

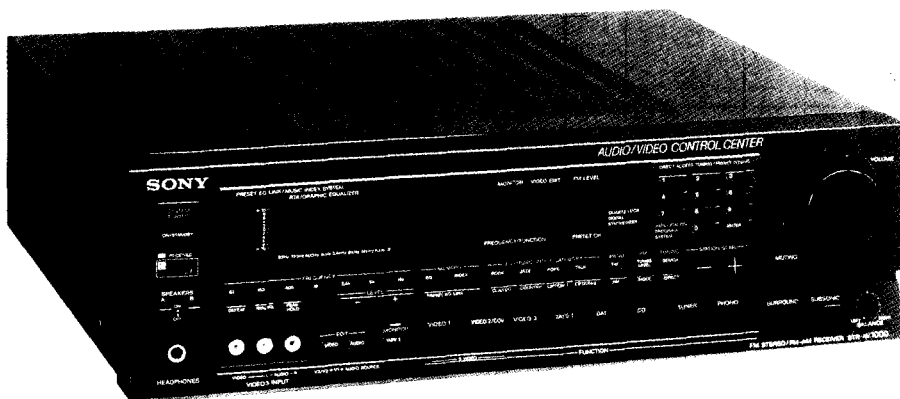

OWNER'S RECORD

The model and serial numbers are located at the rear. Record the serial number in the space provided below. Refer to these numbers whenever you call upon your Sony dealer regarding this product.

Model No. _____ Serial No. _____

WARNING

To prevent fire or shock hazard, do not expose the unit to rain or moisture.

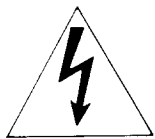
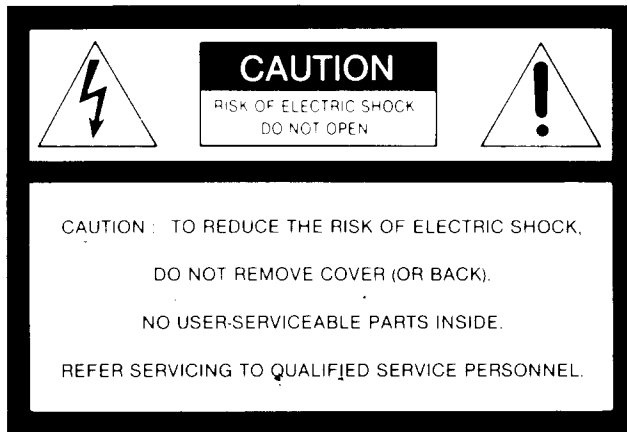

This symbol is intended to alert the user to the presence of uninsulated "dangerous voltage" within the product's enclosure that may be of sufficient magnitude to constitute a risk of electric shock to persons:



This symbol is intended to alert the user to the presence of important operating and maintenance (servicing) instructions in the literature accompanying the appliance.

Note to CATV system installer:

This reminder is provided to call the CATV system installer's attention to Article 820-22 of the NEC that provides guidelines for proper grounding and, in particular, specifies that the cable ground shall be connected to the grounding system of the building, as close to the point of cable entry as practical.

INFORMATION

This equipment generates and uses radio frequency energy and if not installed and used properly, that is, in strict accordance with the manufacturer's instructions, may cause interference to radio and television reception. It has been type tested and found to comply with the limits for a Class B computing device in accordance with the specifications in Subpart J of Part 15 of FCC Rules, which are designed to provide reasonable protection against such interference in a residential installation. However, there is no guarantee that interference will not occur in a particular installation. If this equipment does cause interference to radio or television reception, which can be determined by turning the equipment off and on, the user is encouraged to try to correct the interference by one or more of the following measures:

- Reorient the receiving antenna
- Relocate the equipment with respect to the receiver
- Move the equipment away from the receiver
- Plug the equipment into a different outlet so that equipment and receiver are on different branch circuits.

If necessary, the user should consult the dealer or an experienced radio/television technician for additional suggestions. The user may find the following booklet prepared by the Federal Communications Commission helpful:

"How to Identify and Resolve Radio-TV Interference Problems". This booklet is available from the U.S. Government Printing Office, Washington, DC 20402, Stock No. 004-000-00345-4.

For the customers in Canada

CAUTION:

TO PREVENT ELECTRIC SHOCK, DO NOT USE THIS POLARIZED AC PLUG WITH AN EXTENSION CORD, RECEPTACLE OR OTHER OUTLET UNLESS THE BLADES CAN BE FULLY INSERTED TO PREVENT BLADE EXPOSURE.

Table of Contents

	Outline of STR-AV1000 and STR-AV900	4
	Precautions	4
	Installation	5
	Connections	6
	Notes on connections	6
	Overall connection diagram	6
	Connecting the FM antenna	7
	Connecting the AM antenna	7
	Connecting the antenna ground	8
	Connecting a speaker system	8
	Connecting tape decks	9
	Connecting a CD player	9
	Connecting a turntable system	10
	Connecting a DAT deck	10
	Connecting VCRs	11
	Connecting a monitor TV	11
	Connecting a VCR, monitor TV, etc. equipped with the connectors for component video signal of the luminance and the chrominance	12
	Connecting a portable VCR, etc.	12
	Connecting the remote control system	13
	Connecting the AC power	13
	Parts identification	14
	Front panel	14
	Programmable System Commander RM-P101 (supplied with the STR-AV1000)	16
	Remote commander RM-U80 (supplied with the STR-AV900)	18
	Using the remote commander	20
	Audio adjustment	22
	Receiving radio broadcast programs	23
	Direct tuning	23
	Presetting broadcast stations – Auto-preset	24
	Tuning in preset stations – Station scan tuning	25
	Categorizing preset stations by Music Index	26
	Tuning in a categorized station	27
	Using the graphic equalizer	28
	Creating a new equalization curve	28
	Memorizing a new equalization curve	28
	Listening to a music with a memorized equalization curve	29
	Listening to a music without using the graphic equalizer function	29
	Listening to program sources other than radio broadcasts	30
	Receiving FM simulcast TV programs	30
	Recording on an audio tape or DAT	31
	Video operations	32
	Recording a TV program on a video tape	32
	Video tape editing	33
	Adding new sound on a video tape during video editing	34
Getting Started		
Using Your Receiver	Specifications	35
Troubleshooting	Troubleshooting guide	36
Quick Reference	Quick reference	38

Outline of the STR-AV1000 and STR-AV900

The STR-AV1000/900 is a combined receiver and audio/video control center. You can enjoy various audio/video program sources with this unit.

TV/Video Programs

- You can enjoy TV or CATV programs with FM simulcast.
- Sounds from various audio program sources can be added on video tapes during editing.

Tuner

- Precise tuning is ensured by a quartz lock digital synthesizer.
- All receivable stations can be preset automatically.

Electronic graphic equalizer and Music Index system

- You can enjoy audio program sources with an appropriate equalization curve.
- Memorization of equalization curve is possible as well as curve adjustment.
- Combined use of the graphic equalizer and the Music Index system allows you to very quickly tune in a preset broadcast station and immediately enjoy the sound with the memorized equalization curve.

Remote control

- The supplied remote commander allows you to remotely control both the unit and the equipment connected to the unit.
- The commander supplied with the STR-AV1000 can learn various functions of other remote commanders of the infrared type.

Display

- The frequency of each tuned-in broadcast station is displayed.
- The current selection/operation is displayed to clearly indicate what is taking place.

General

- The surround sound system enhances live atmosphere of the sound.

Precautions

On safety

- Operate the unit only on 120 V AC, 60 Hz.
- Should any solid object or liquid fall into the cabinet, unplug the unit and have it checked by qualified personnel before operating it any further.
- Unplug the unit from the wall outlet if it is not to be used for an extended period of time. To disconnect the cord, pull it out by grasping the plug. Never pull the cord itself.
- One blade of the plug is wider than the other for the purpose of safety and will fit into the power outlet only one way. If you are unable to insert the plug fully into the outlet, contact your dealer.

On operation

Before making program source connections, be sure to unplug the unit.

On cleaning the cabinet

Clean the cabinet, panel and controls with a soft cloth slightly moistened with mild detergent solution. Do not use any type of abrasive pad, scouring powder, or solvent such as alcohol or benzene.

For the customers in U.S.A.

For detailed safety precautions, see the "IMPORTANT SAFEGUARDS" leaflet.

If you have any question or problem concerning your unit, please consult your nearest Sony dealer.

Installation

Notes on Installation

Place the unit in a location with adequate air circulation to prevent internal heat build-up in the unit.

This way

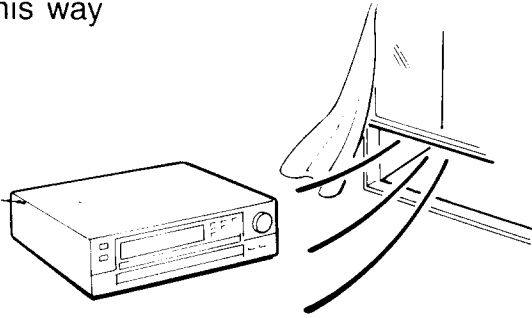

Not this way

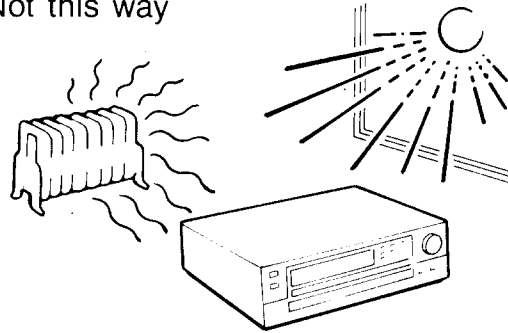

Do not install this unit:

- near heat sources such as radiators or air ducts.
- in a place subject to direct sunlight, excessive dust, mechanical vibration or shock.

Do not place anything on top of the cabinet. The top ventilation holes must be unobstructed for the proper operation of the unit and to prolong the life of its components.

Loading the Batteries into the Remote Commander

RM-P101 Programmable System Commander
(supplied with STR-AV1000)

1

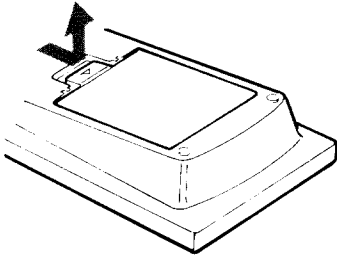

2

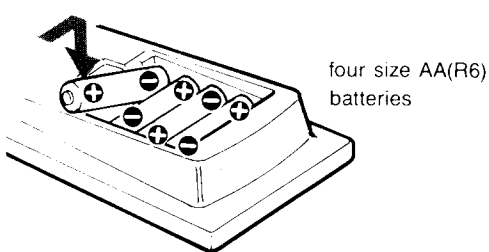

RM-U80 Remote Commander
(supplied with STR-AV900)

1

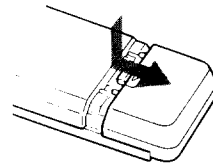

2

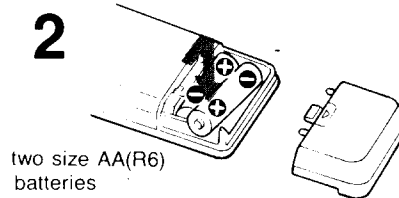

Do not throw away the carton and packing material.

It will be an ideal container when transporting the unit for repair work, etc.

To avoid damage caused by battery leakage and corrosion

When the commander will not be used for a long time, remove the batteries.

Battery life

About a half year of normal operation can be expected when using the Sony SUM-3(NS) batteries.

When the batteries are run down, the remote commander will not operate the unit. In this case, replace the batteries with new ones.

Connections

Notes on Connections

- Do not connect the power cord to an AC outlet nor press the SYSTEM POWER switch before accomplishing all other connections.
- The cable connectors should be fully inserted into the jacks. Loose connection may cause hum and noise.
- Cord plugs and jacks are color coded. Red plugs and jacks are for right channel (R) and white ones for left channel (L).

Overall Connection Diagram

The numbers placed in a circle ● correspond to those of the individual connecting diagrams given on the following pages.

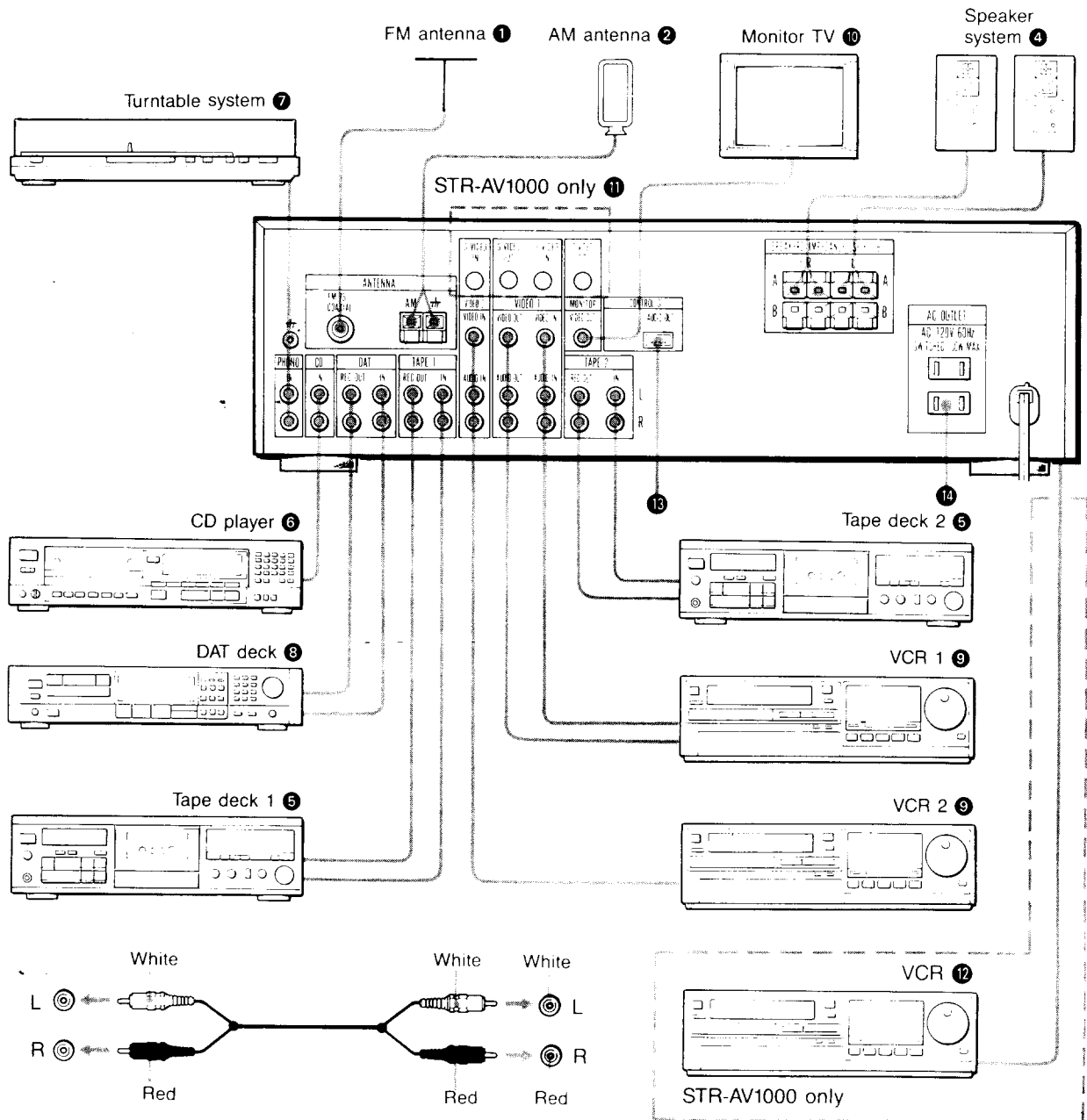

1 Connecting the FM Antenna

STR-AV1000/900

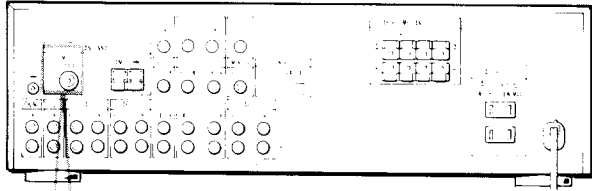

Ribbon antenna supplied
(or 300-ohm twinlead) connection

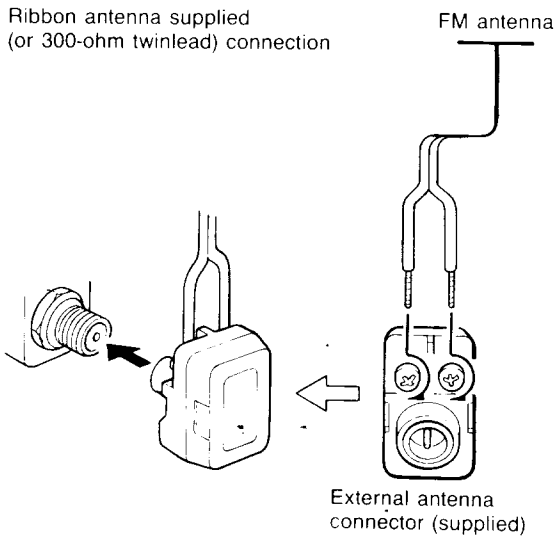

75-ohm coaxial cable connection

A 75-ohm coaxial cable is free from external interference, reduces noise pickup, and is the ideal transmission line for most FM installations. 3C-2V cable is recommended. Connect the 75-ohm coaxial cable to the supplied antenna connector and connect it to the FM antenna connector.

- 1 Open the lid.
- 2 Strip the cable.

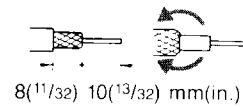
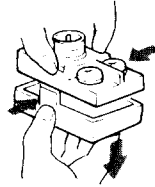

- 3 Remove the ring.
(Keep it in the projection on the lid.)

- 4 Loosen the screws and insert the cable

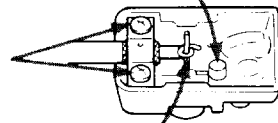

- 5 Coil the center conductor

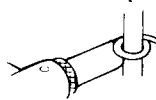

- 6 Snap the cover into place.

2 Connecting the AM Antenna

STR-AV1000/900

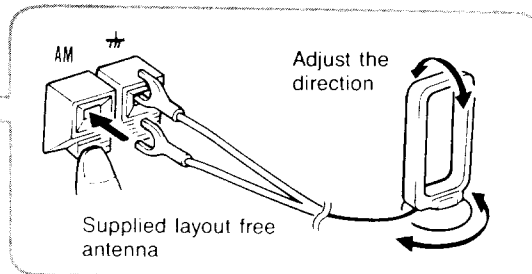
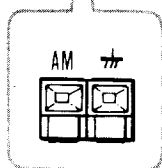
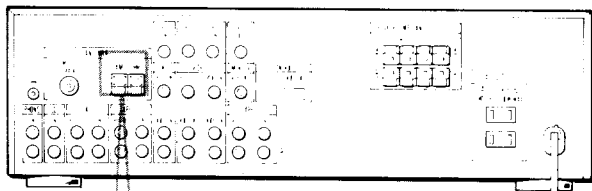

For areas with difficult AM reception

In areas with troubled reception, connect a 6- to 15-meter (20- to 50-foot) insulated wire to the AM antenna terminal. Extend this out of doors if possible, keeping the greater portion horizontal. (There is no need to disconnect the supplied antenna.)

③ Connecting the Antenna Ground

To prevent hum, connect the ground wire to ANTENNA ground terminal (⚡).
When an outdoor antenna is installed, be sure to connect the ground wire for lightning protection.

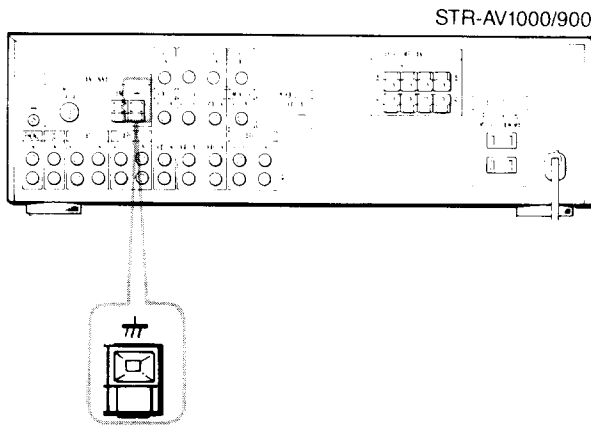

④ Connecting a Speaker System

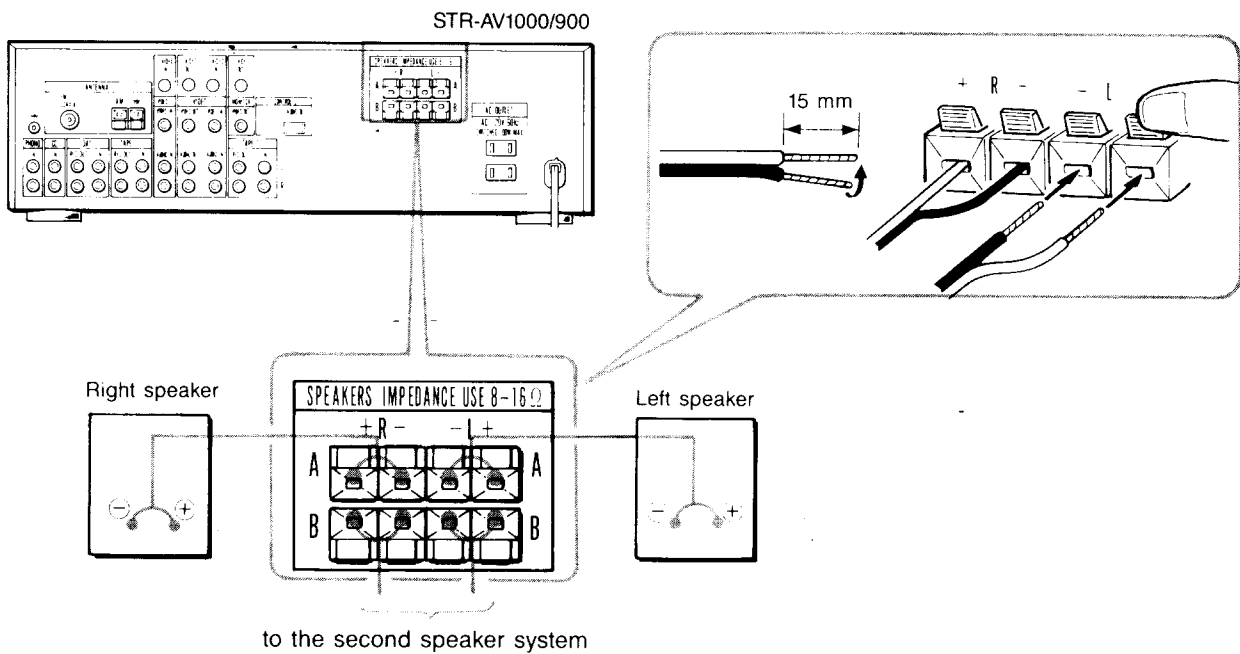

Speaker impedance and power capability

This receiver is designed to work best with speakers having nominal impedance from 8 to 16 ohms, at rated 120 watts (STR-AV1000) or 100 watts (STR-AV900) minimum RMS per channel with an 8-ohm load from 20–20,000 Hz.

5 Connecting Tape Decks

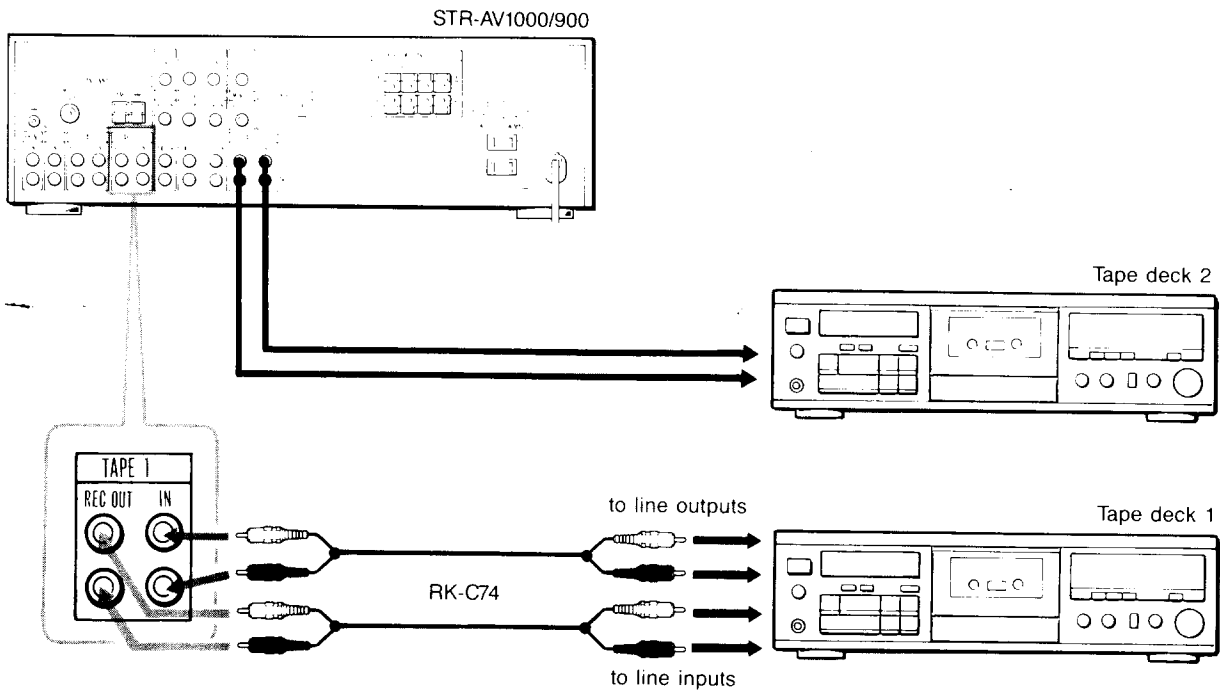

6 Connecting a CD Player

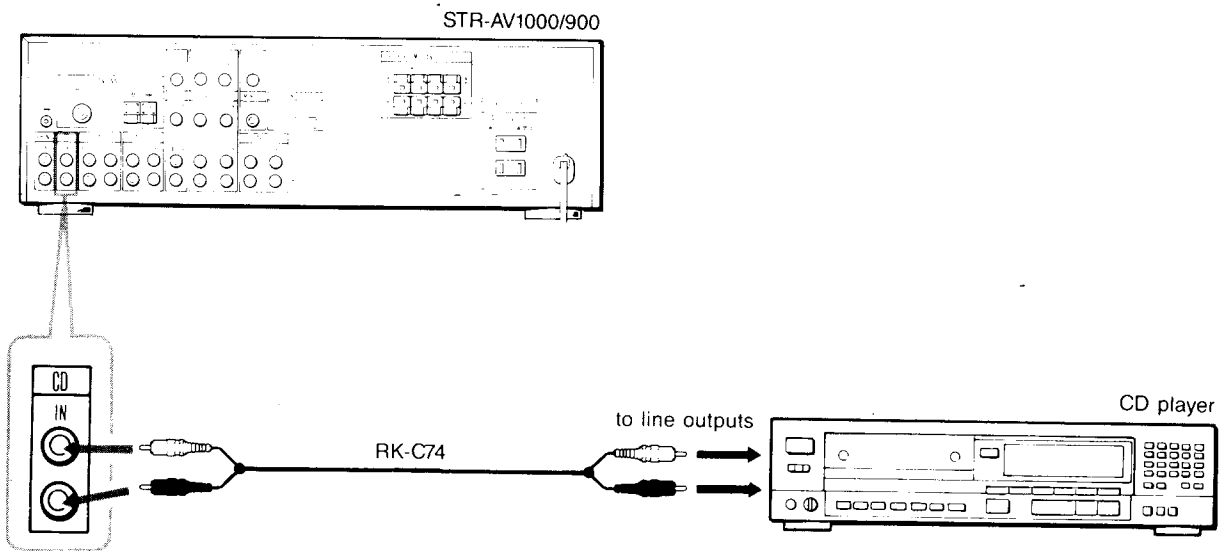

Connections

7 Connecting a Turntable System

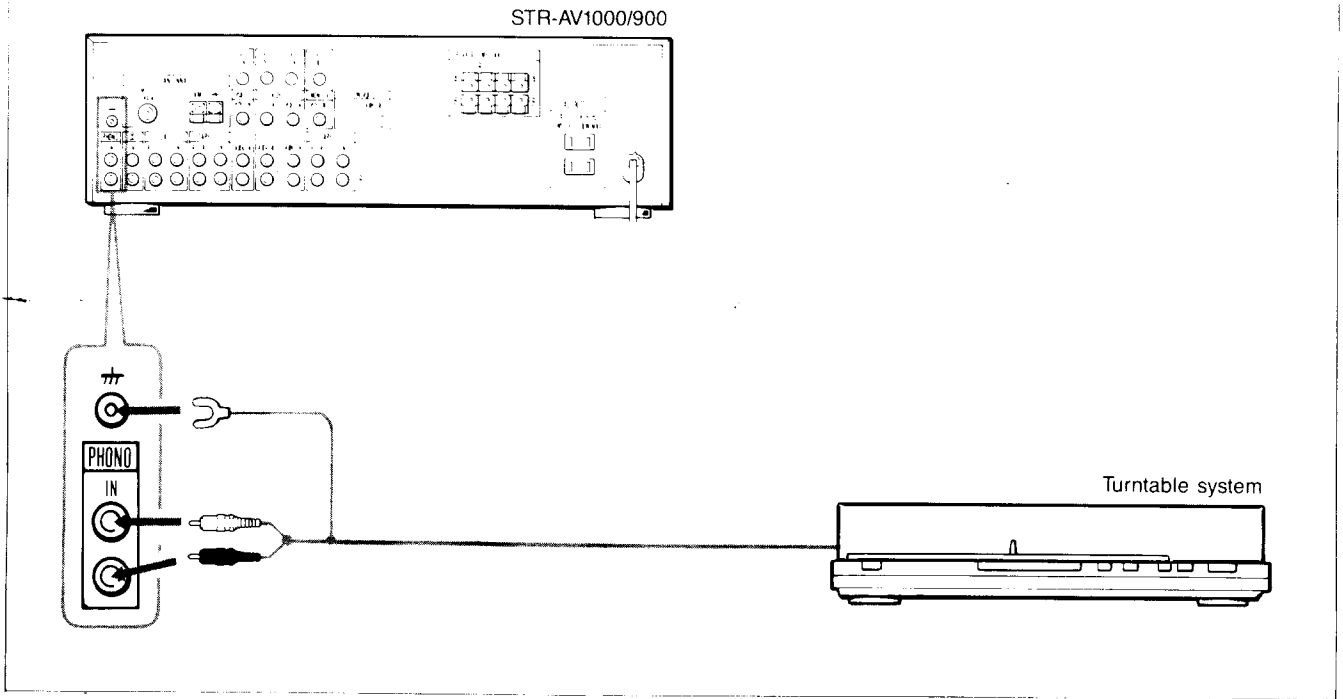

8 Connecting a DAT Deck

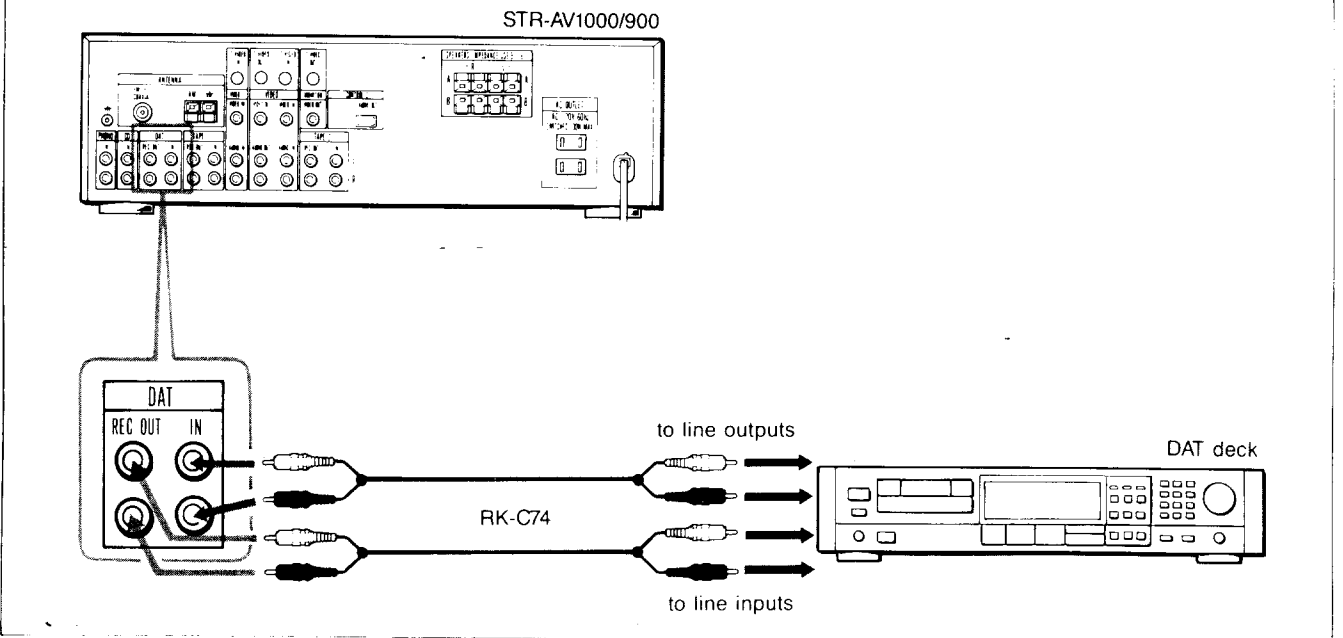

9 Connecting VCRs

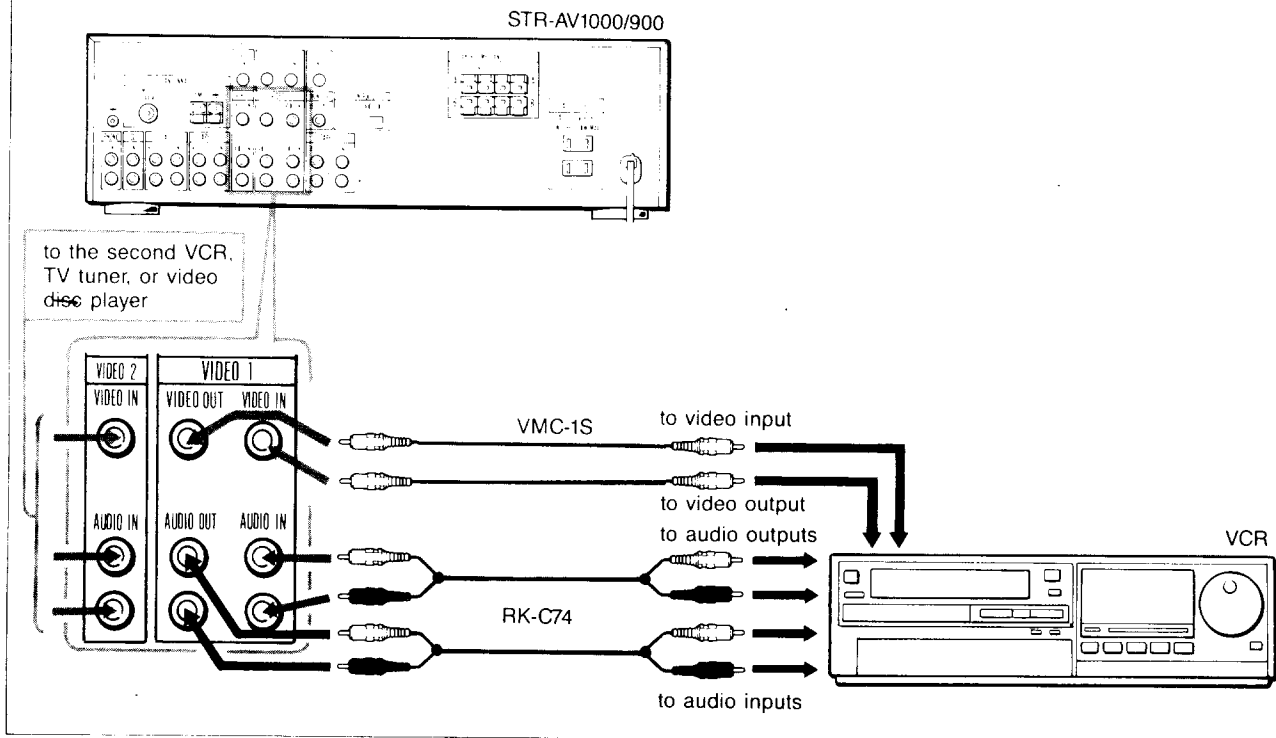

10 Connecting a monitor TV

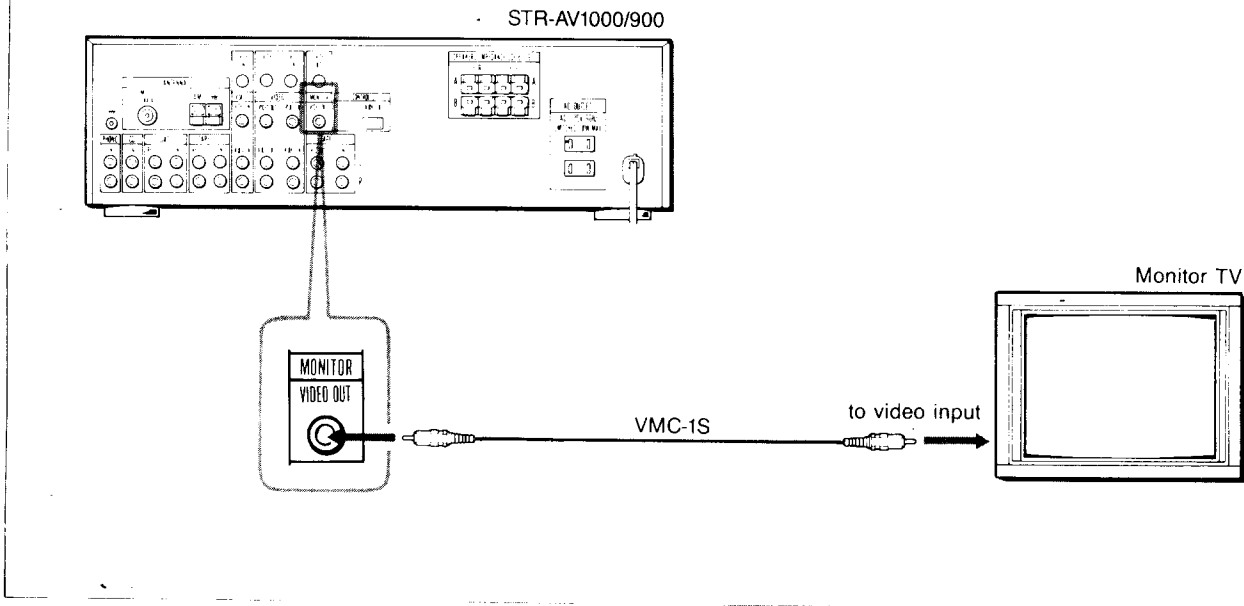

Connections

● Connecting a VCR, Monitor TV, etc. Equipped with the Connectors for Component Video Signal of the Luminance and the Chrominance

This connection is possible only with the STR-AV1000.

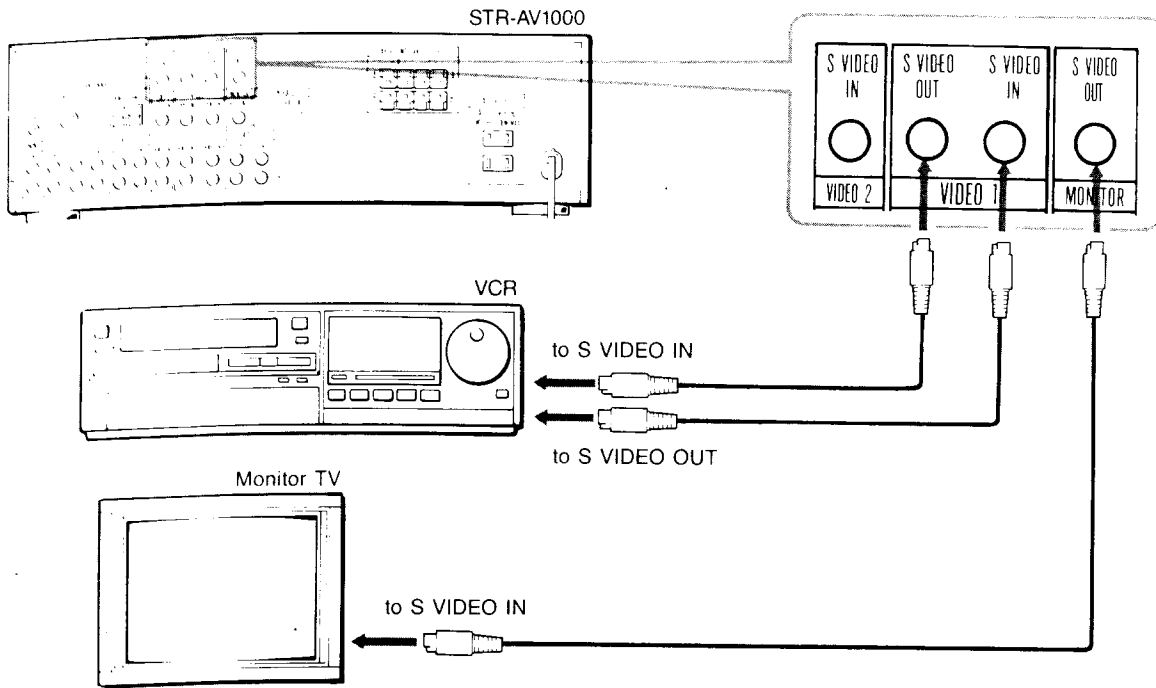

● Connecting a Portable VCR, etc.

This connection is possible only with the STR-AV1000.

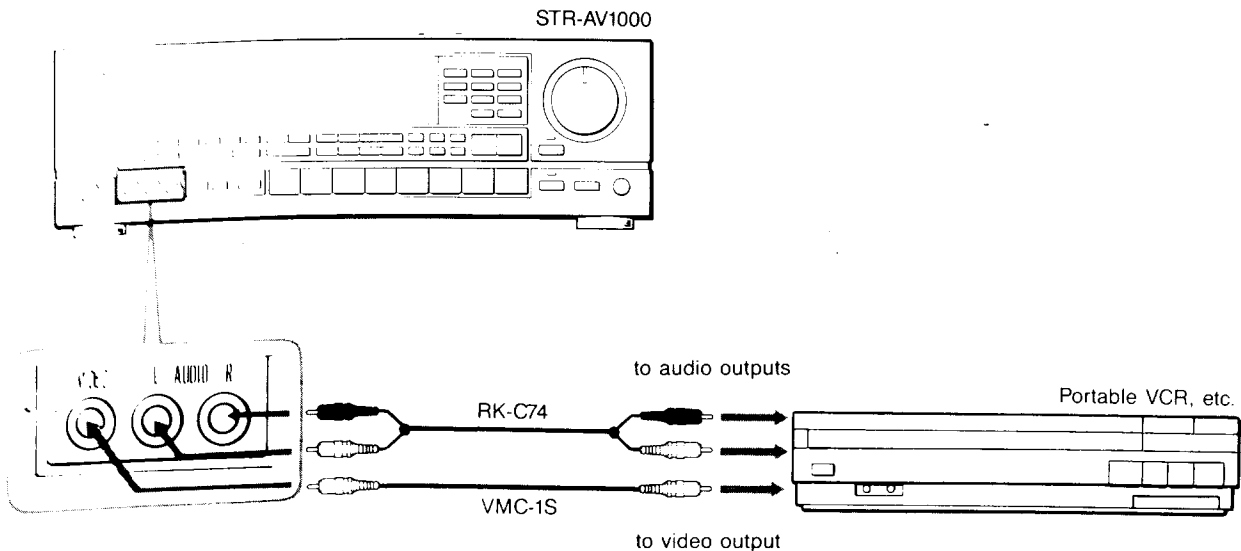

13 Connecting the Remote Control System

To control the equipment connected to the receiver with the remote commander, connect the CONTROL S OUT connector and the CONTROL S IN connector of each equipment as illustrated below.

Example of audio connection

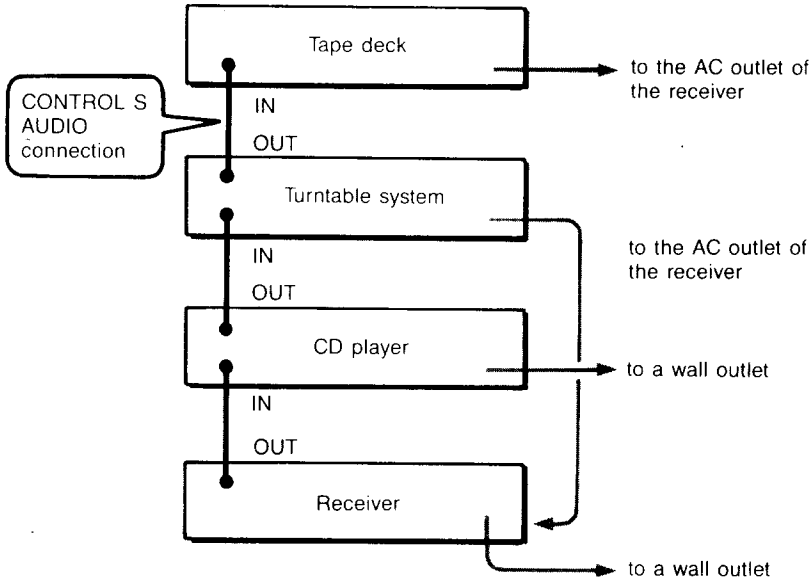

14 Connecting the AC Power

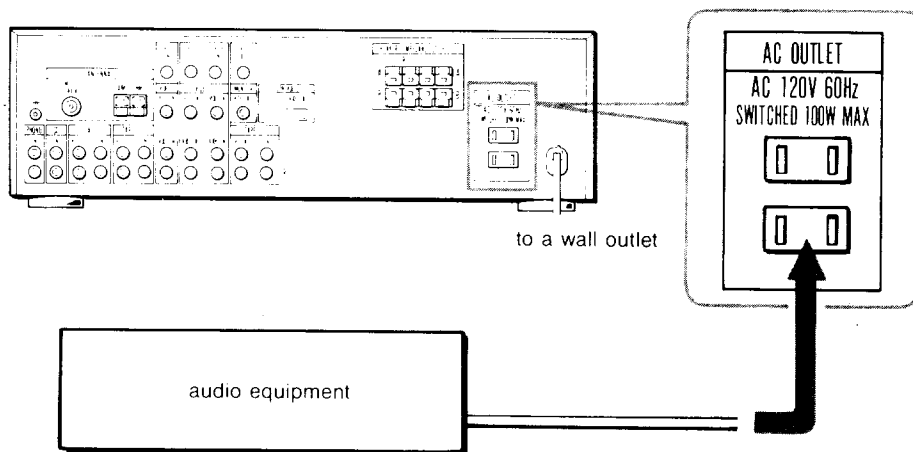

Caution

Be careful that the total power consumption of each equipment connected to the outlets on the receiver does not exceed 100 watts.

Do not connect electrical home appliance such as an electric iron, fan, TV, or other high-wattage equipment to these outlets.

Parts Identification

Front Panel

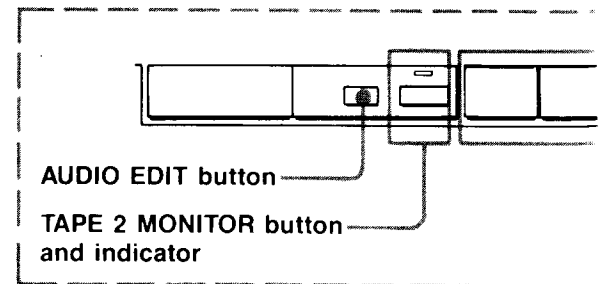
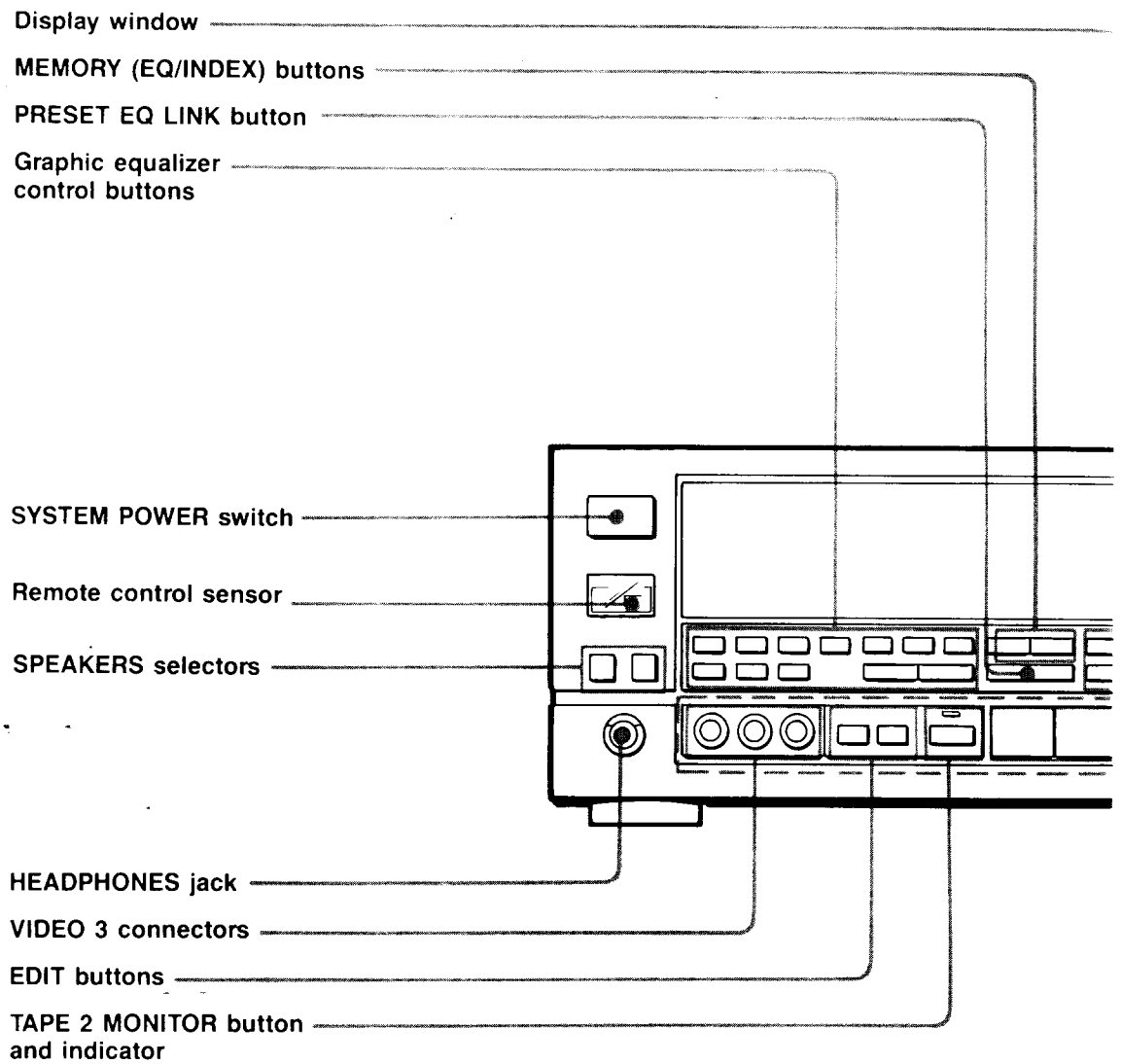

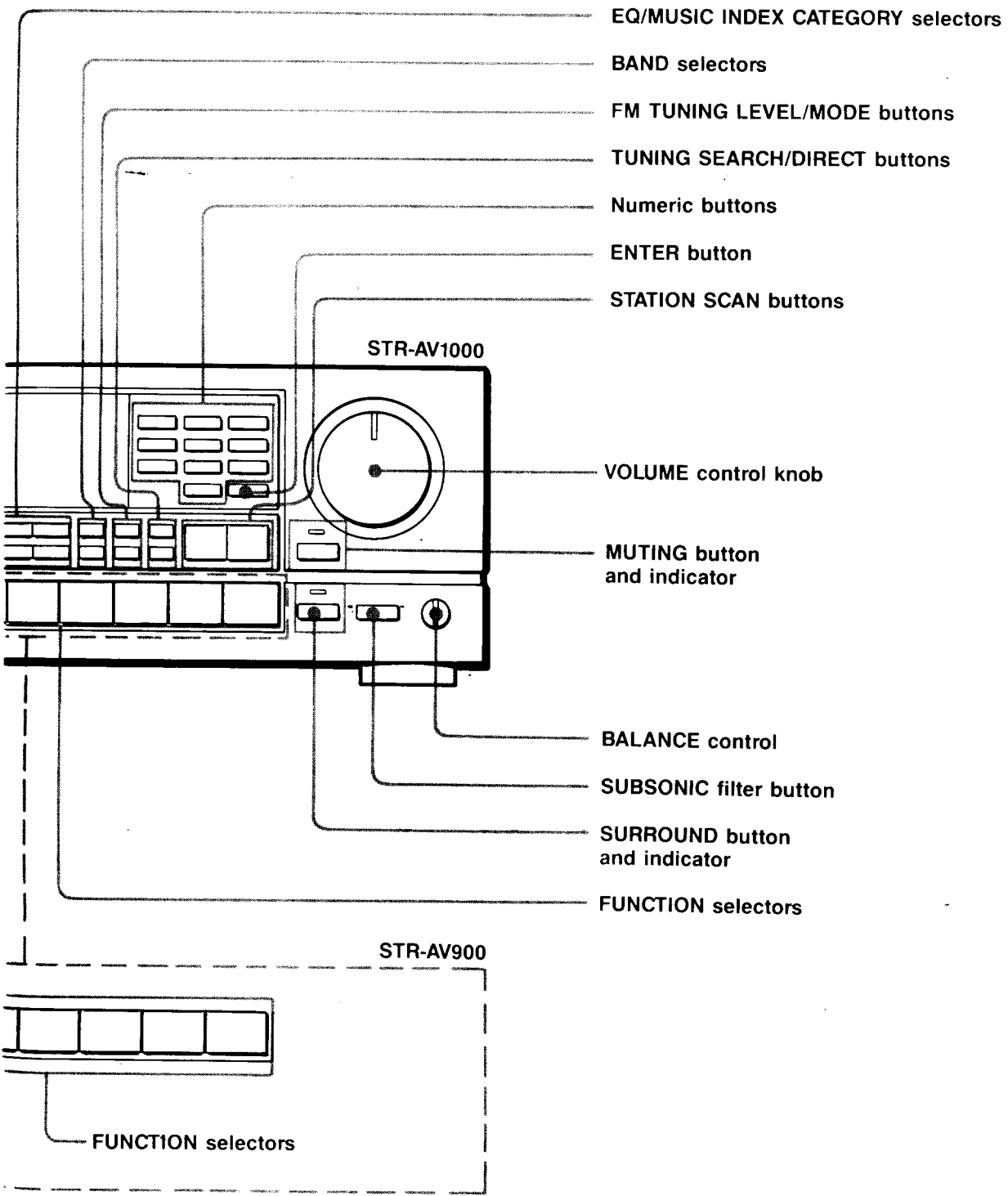

Parts Identification

Programmable System Commander RM-P101 (supplied with the STR-AV1000)

The Programmable System Commander RM-P101 supplied with the STR-AV1000 can learn various functions of other remote commanders emitting infrared rays. When it is set to SONY STD (Sony Standard) by the mode selector, its buttons can be used to perform the functions below.

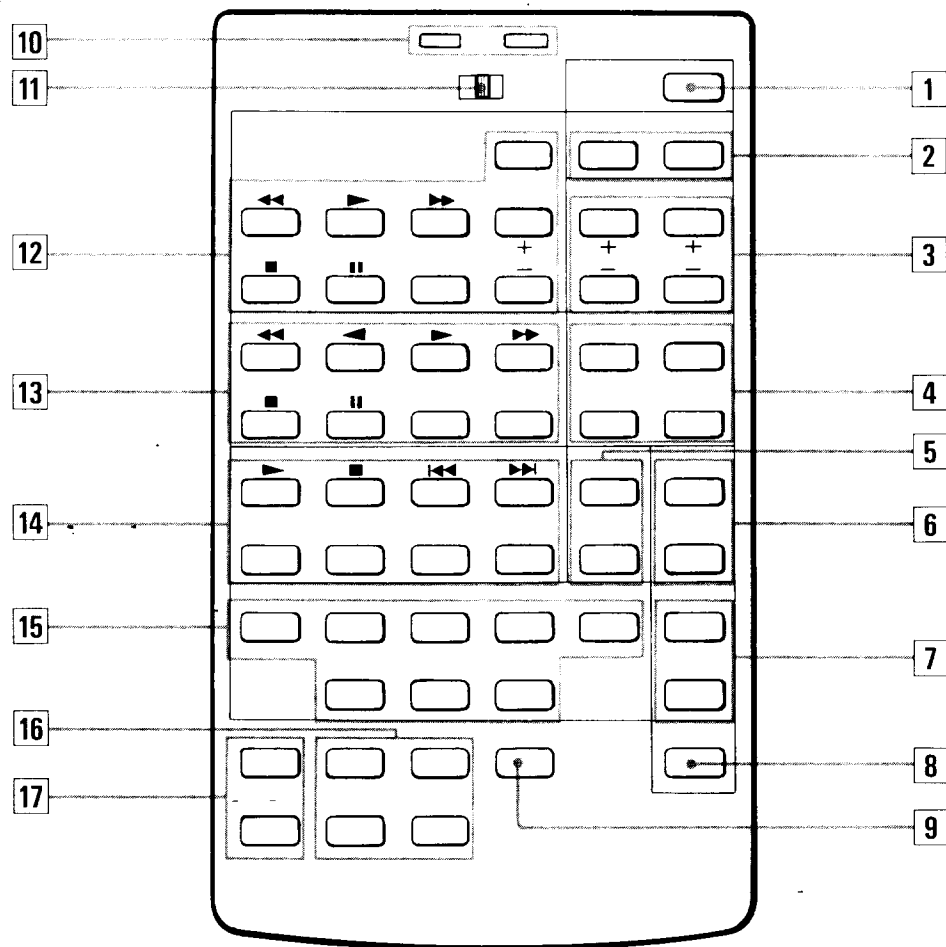

Notes

- When the CONTROL S OUT connector is connected to the CONTROL S IN connector of each equipment, you can control the connected equipment using this remote commander.
- SHUFFLE and PGM modes of some CD players cannot be cleared by this remote commander. In such case, clear the modes using the CD player itself or with the remote commander supplied with the CD player.
- When the system is in the LINK ON state, those index categories under which no broadcasting stations have been preset cannot be selected.

Note on the ● (recording) button under [12] VTR operation buttons

If your VCR is of such type as pressing ● puts it in REC PAUSE mode, first press ● on this commander and then II.

1 POWER ON/OFF button

Turns on/off the receiver.

2 POWER ON/OFF buttons

TV: Turns on/off the TV.

VTR: Turns on/off the VCR 1, 2 or 3.

3 TV operation buttons

TV CH: Channel select buttons

TV VOL: Volume control buttons

4 Spare buttons

Functions of other remote commanders can be learned on these buttons. (See "Using the Learning Function," page 20.)

5 PHONO buttons

START: Starts record play.

STOP: Stops record play.

6 TUNER PRESET buttons

+: Selects a higher preset channel number.

-: Selects a lower preset channel number.

7 VOLUME control buttons

8 MUTING button

9 SURROUND ON/OFF button

10 LEARNED and READY indicators

LEARNED: Lights up when learning of a function of other commander is complete.

READY: Lights up when the commander is ready to learn a function of other commander.

11 Mode selector

LEARN: To perform learning function.

SONY STD.: To operate the commander on Sony Standard.

USER STD.: To use the learned functions.

12 VTR operation buttons

◀◀: Rewind

▶: Play

▶▶: Fast forward

TV/VTR: Select the output signal from the VCR, either a TV signal or VCR programs.

VTR CH: VCR channel select buttons

■: Stop

||: Pause

●: Recording (While you press ●, press ▶)

Notice: If your VCR has a command mode selector and it is set to VTR 1, these buttons will operate only when the mode selector of this commander is set to SONY STD. If the VCR's selector is set to VCR 2, the mode selector must be set to USER STD.

13 TAPE deck operation buttons

◀◀: Reverse fast winding

◀: Reverse play

▶: Forward play

▶▶: Forward fast winding

■: Stop

||: Pause

●: Recording (While you press ●, press ◀ or ▶.)

○: Record muting

Note: If your tape deck is a double-deck type, refer to its instruction manual concerning the deck which can be controlled with this commander.

14 CD player operation buttons

▶: Starts play.

■: Stops play.

◀◀/▶▶: AMS (Automatic Music Sensor)

DISC SELECT: Effective only when the connected CD player is equipped with a disc changer.

REPEAT: Repeat play

SHUFFLE: Shuffle play

PGM: Program play

15 Function selectors

16 GRAPHIC EQUALIZER control buttons

FREQ: Frequency select buttons

+: Selects a higher frequency.

-: Selects a lower frequency.

LEVEL: Level select buttons

+: For higher level

-: For lower level

17 Music Index select buttons

+: Each time you press this button, a different Music Index is selected in the following order:

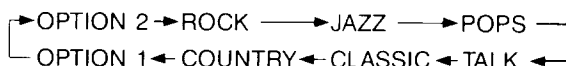

-: A different Music Index is selected in the order reverse to "+".

Parts Identification

Remote Commander RM-U80 (supplied with STR-AV900)

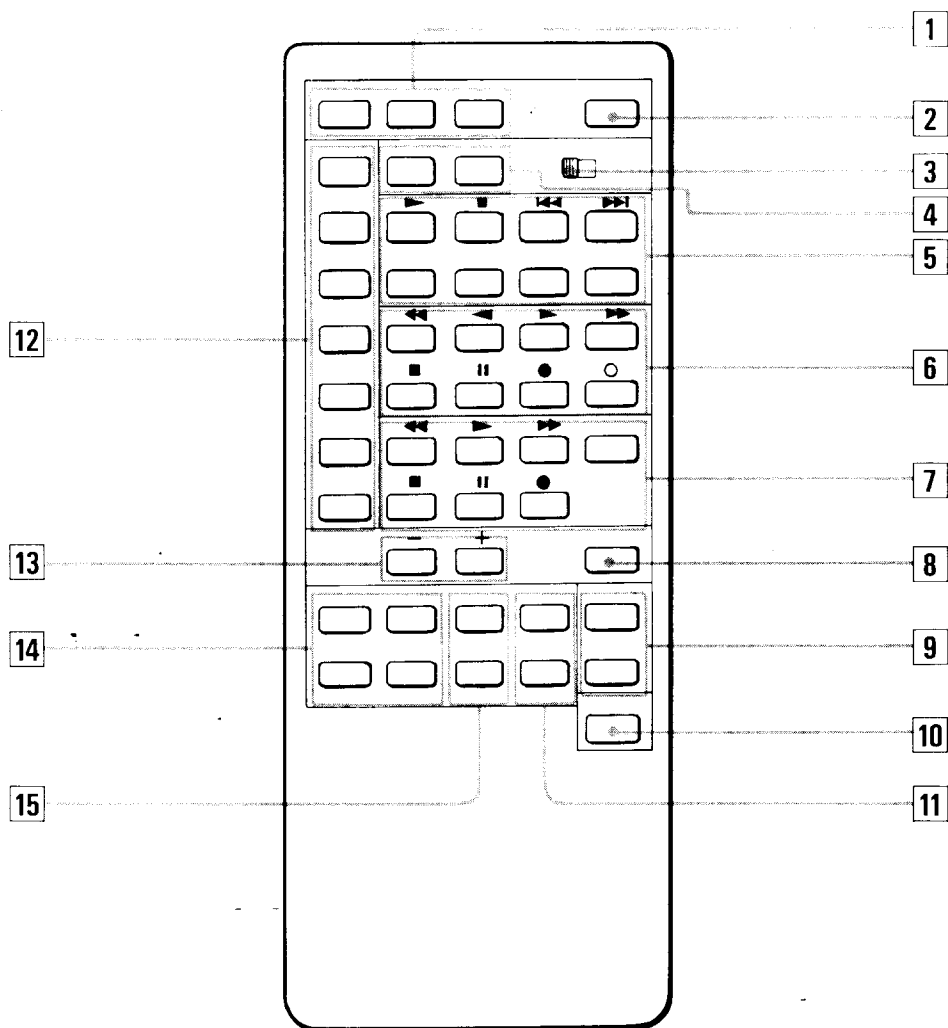

Notes

- When the CONTROL S OUT connector is connected to the GONTROL S IN connector of each equipment, you can control the connected equipment using this remote commander.
- SHUFFLE and PGM modes of some CD players cannot be cleared by this remote commander. In such case, clear the modes using the CD player itself or with the remote commander supplied with the CD player.
- When the system is in the LINK ON state, those index categories under which no broadcasting stations have been preset cannot be selected.

Note on the ● (recording) button under [7] VTR operation buttons

If your VCR is of such type as pressing ● puts it in REC PAUSE mode, first press ● on this commander and then II.

1 POWER ON/OFF buttons

TV: Turns on/off the TV.

VTR: Turns on/off the VCR 1 or 2.

AUDIO: Turns on/off the receiver.

2 SYSTEM POWER OFF button

Turns off the receiver, TV, VCR 1 and 2.

3 TAPE and VTR selector

TAPE A: Selects the tape in a single-deck unit or the tape in the "A" deck of a double-deck unit.

TAPE B: Selects the tape in the "B" deck of a double-deck unit.

VTR1/2: If your VCR has a command mode selector, set this switch to the same position as that of the command mode selector.

If not, set this switch to VTR1.

Notice: The TAPE A/B selector is usable for TC-WR950. If you use another double deck with "control-S", you can operate one side of the deck.

4 PHONO buttons

START: Starts record play.

STOP: Stops record play.

5 CD player operation buttons

▶: Starts play.

■: Stops play.

◀▶ / ▶▶: AMS (Automatic Music Sensor)

D. SELECT: Effective only when the connected CD player is equipped with a disc changer.

REPEAT: Repeat play

SHUFFLE: Shuffle play

PGM: Program play

6 TAPE deck operation buttons

◀◀: Reverse fast winding

◀: Reverse play

▶: Forward play

▶▶: Forward fast winding

■: Stop

||: Pause

●: Recording (While you press ●, press ◀ or ▶.)

○: Record muting

7 VTR operation buttons

◀◀: Rewind

▶: Play

◀◀: Fast forward

TV/VTR: Select the output signal from the VCR, either a TV signal or VCR programs.

■: Stop

||: Pause

●: Recording (While you press ●, press ▶.)

8 SURROUND ON/OFF button

9 VOLUME control buttons

10 MUTING button

11 TUNER PRESET buttons

+: Selects a higher preset channel number.

-: Selects a lower preset channel number.

12 FUNCTION selectors

13 Music Index select buttons

+: Each time you press this button, a different Music Index is selected in the following order:



-: A different Music Index is selected in the order reverse to "+".

14 TV operation buttons

TV CH: Channel select buttons

TV VOL: Volume control buttons

15 VTR CH: VCR channel select buttons

Using the Remote Commander

- When you manipulate a switch or button on the commander, be sure to point the head of the commander toward the remote control sensor on the front of the receiver.
- If there is an obstacle between the receiver and the head of the commander, the receiver may not be controlled remotely.

Using the Learning Function of the Programmable System Commander RM-P101 (for STR-AV1000)

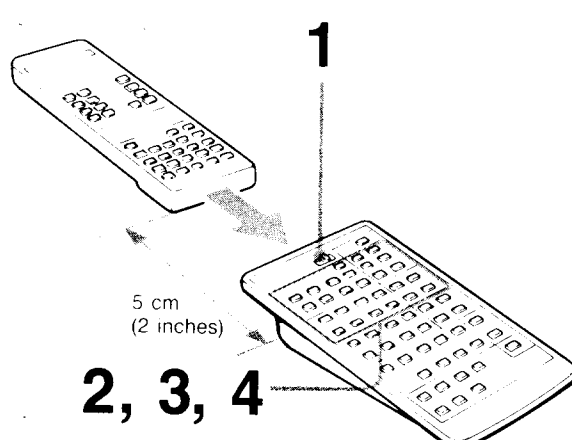

- 1 Set the mode selector to LEARN.**
The READY indicator lights up.
- 2 Turn this commander towards another commander and press any button in the programmable area on which you want a function of the other commander to be memorized.**
If the selected button is inoperative, the READY indicator flickers.
- 3 While keeping the button pressed, press the desired function button on the other commander.**
The function is memorized by this unit. When the memorization is complete, the READY indicator goes out and the LEARNED indicator lights up.
- 4 Release the button.**
The LEARNED indicator goes out and the READY indicator lights up to indicate that the next learning is ready to start.

When learning is finished

- Set the mode selector to USER STD. to use learned functions.
- Set the mode selector to SONY STD. to use Sony standard functions.

The memorization will be remained

For two or three days without installing the batteries.

Caution

Be sure to check if the functions have been stored, because a few of the functions of other manufacturer's commanders are not storable on this commander.

If the RM-P101 cannot control other Sony audio/video equipments

Make it learn functions of the remote commander for each equipment following the above steps. After learning operation, be sure to use it with the mode selector set to USER STD. in this case, too.

If both LEARNED and READY indicators light up

The batteries are becoming exhausted. Replace all four batteries with new ones.

Making the commander learn the recording function

Be sure to press the ◀ or ▶ button while keeping the ● button pressed. The learning may not be performed if you press ● only.

To activate recording using the learned function, press ◀ or ▶ while keeping ● pressed.

When the mode selector is set to USER STD.

- Pressing a button on which no function has been learned will always activate the Sony standard function assigned to that button.
- No function will be activated if the pressed button has learned unrelated signals such as noise from fluorescent light.
- The TV/VTR buttons control VCR 2 such as Sony 8 mm VCR.

Avoiding memorization of noise or useless signals

When using the learning function, be sure to handle both commanders away from a noise source and put the commanders themselves close to each other.

If the READY indicator doesn't light up at step 1 or 4

The learning function will not work well. This may occur when you handle the commanders close to a noise source such as a fluorescent light or an equipment emitting infrared rays.

Remove both commanders away from the noise source.

If the LEARNED indicator flickers at step 3

The RM-P101's memory has been occupied by noise or useless signals to it's all capacity.

If this situation occurs, you cannot use the learning function any more before once erasing all contents of the memory.

Erasing the contents of the memory

1. Set the mode selector to LEARN.
2. While keeping the ◀◀ of the VCR operation buttons pressed, press the MUTING button.

Audio Adjustment

You can enjoy superb sounds using the audio adjustment functions as shown below.

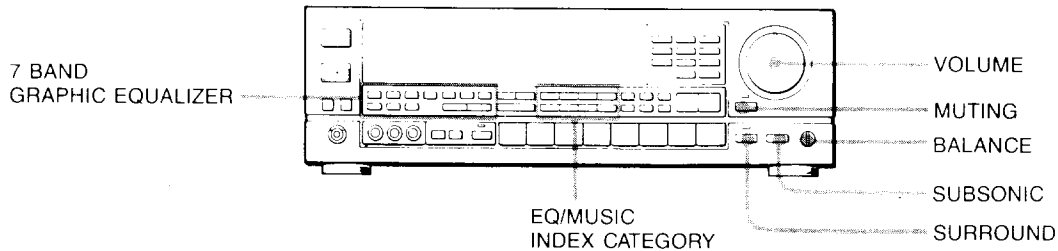

Volume Adjustment

Adjust the **VOLUME** control.

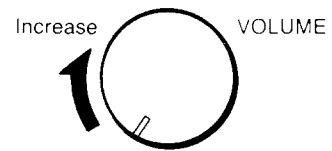

Temporarily reducing the sound to a low level (-20 dB attenuation)

Press **MUTING**.

Press again to restore the previous level.

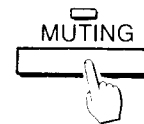

Balance Adjustment

Changing the relative output strength of the right and left speakers

Adjust **BALANCE** to correct stereo imaging, when the speaker position is not symmetrical.

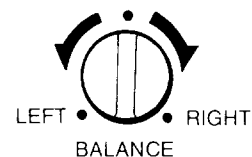

Sound Quality Adjustment

Selecting a standard equalization curve for each music
You can readily enjoy a music with a standard equalization curve factory-preset for the category of that

music. If you are to listen to a rock music for example, press the **EQ/MUSIC INDEX CATEGORY** button marked "ROCK."

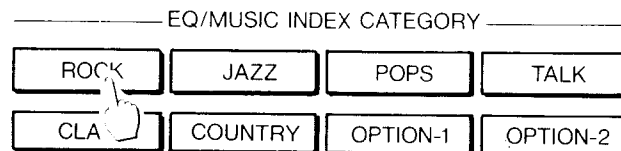

Note

This operation cannot be performed while the **DEFEAT** or the **LINK** indicator is lit. Press the **DEFEAT** or the **PRESET EQ LINK** button to make the indicator go out.

Creating and/or Memorizing a New Equalization Curve

See "Using the Graphic Equalizer," page 28.

Enjoying the surround sound

Press **SURROUND** when listening to a stereo source.

Press again to turn off the effect.



Reducing unwanted subsonic noise components created by warped records, etc.

Press **SUBSONIC**.

Press again to disengage the subsonic filter.

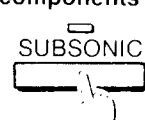

Receiving Radio Broadcast Programs

Direct Tuning

SYSTEM POWER → ON

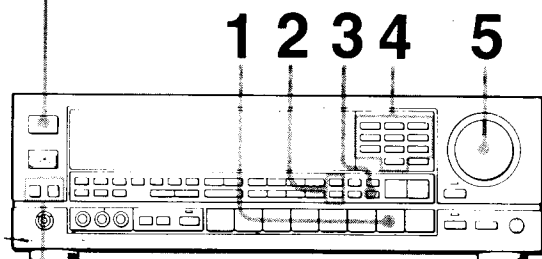

Select SPEAKERS A or B

- 1 Select the function TUNER.
- 2 Select FM or AM.
- 3 Press TUNING DIRECT.
- 4 Enter the frequency of the desired station by pressing the appropriate numeric buttons. The entered frequency is displayed.
- 5 Adjust the volume.

Example 1: FM 102.50 MHz

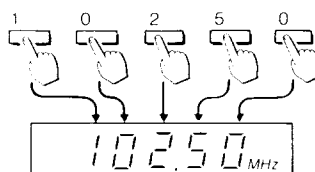

Example 2: AM 1350 kHz

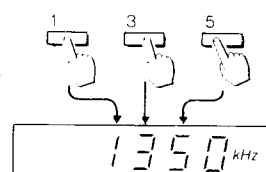

Tuning intervals for direct tuning

FM: 50 kHz interval

AM: 10 kHz interval (changeable to the 9 kHz interval)

Changing the AM tuning interval

The AM tuning interval is preset to 10 kHz. To use the receiver where the frequency allocation system is based on the 9 kHz interval, make the following adjustments:

- 1 Turn on the power and tune in any AM station.
- 2 Press SYSTEM POWER to turn off the receiver.
- 3 Press again SYSTEM POWER to turn on the receiver while pressing STATION SCAN +.

Resetting the AM tuning interval

Follow the procedure for changing the AM tuning interval.

Caution

When the interval is changed, all preset AM stations which you have memorized will be erased. After changing the interval, be sure to newly preset stations. (See "Presetting Broadcast Stations," page 24.)

When the entered number is not in the receivable frequency range

The entered digits (up to 5 digits for FM or up to 4 digits for AM) blink in the frequency display area, and reception does not take place.

If this condition occurs, press TUNING DIRECT again, and enter the correct frequency (the frequency range of the receiver is 87.50 to 107.90 MHz for FM, and 530 to 1610 kHz for AM).

Correcting the entered frequency

Repeat Steps 3 to 5 of Direct Tuning.

For entering AM frequencies, you need not enter the last "0".

However, if you have changed the AM tuning interval to 9 kHz, enter all the digits.

If you enter a frequency not covered by the tuning interval

The entered value is automatically rounded up or down to the closest value covered by the tuning interval.

When an FM stereo program is noisy

When the unit receives an FM stereo program, the STEREO indicator goes on in the display window. If the stereo program is noisy, press FM MODE to change the mode over to MONO. This eliminates the stereo effect, but the noise will be greatly reduced. To return to the stereo mode, press FM MODE again.

Receiving Radio Broadcast Programs

Presetting Broadcast Stations – Auto-preset

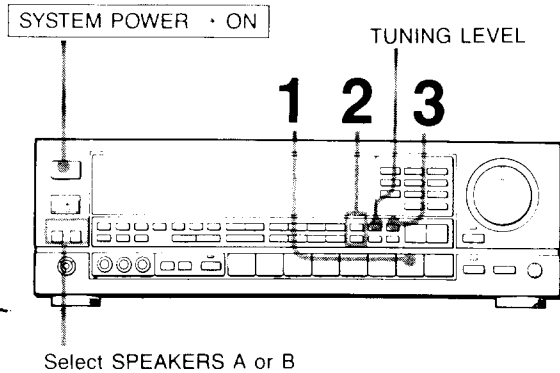

- 1** Select the function **TUNER**.
- 2** Select **FM** or **AM**.
- 3** Press **TUNING SEARCH**.
Frequency search starts from the minimum frequency of the selected band. Each time a station is caught, its frequency is automatically memorized (that is, the station is preset). When this operation is complete, the last memorized station is tuned in.

Selecting the signal level of the station to be preset

You can select "high" or "low" as the FM tuning level by **FM TUNING LEVEL**. Each time you press this button, the characters **HIGH** or **LOW** are displayed in the display window.

HIGH: The frequencies of strong signal stations only will be memorized.

LOW: The frequencies of all receivable stations will be memorized.

How many stations have been preset?

The total number of preset stations are displayed in the **PRESET CH** area of the display window. However, if more than 99 stations have been preset, "--" is displayed instead of the number.

Music index automatically assigned to the stations preset by search operation

All stations preset by search operation are memorized under category **OPTION-2**.

For the procedure of assigning the desired index to any preset station, refer to "Categorizing Preset Stations by Music Index," page 26.

Tuning in Preset Stations – Station Scan Tuning

SYSTEM POWER → ON

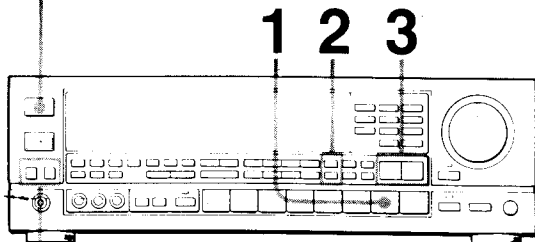

Select SPEAKERS A or B

Method A

- 1 Select the function TUNER.
- 2 Select FM or AM.
- 3 Select the desired preset station by the STATION SCAN + or - button.
 - Each time you press STATION SCAN + (or -), a preset station of next higher (or lower) channel number is tuned in.
 - If you keep pressing + (or -), preset stations are successively tuned in in the increasing (or decreasing) order of channel number. Release the button when the desired station is tuned in.
 - Scanning of the preset stations takes place cyclically from AM to FM and vice versa.

SYSTEM POWER → ON

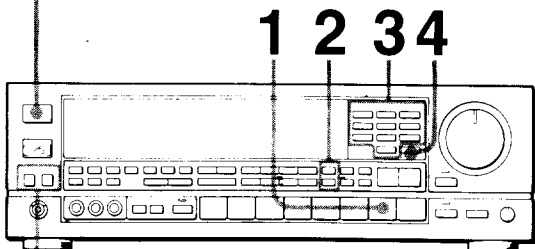

Select SPEAKERS A or B

Method B

- 1 Select the function TUNER.
- 2 Select FM or AM.
- 3 Enter the channel number of the desired preset station by using numeric buttons.
- 4 Establish the channel number entry by pressing the ENTER button.

Notes on Method A

- When the receiver is in the LINK OFF state, all preset stations can be scanned.
- When the receiver is in the LINK ON state, only those preset stations which belong to the music index category that is displayed at present.
- For LINK ON/OFF selection, use the PRESET EQ LINK button. (For details, see "Using the Graphic Equalizer," page 28.)

Receiving Radio Broadcast Programs

Categorizing Preset Stations by Music Index

You can divide preset stations under up to eight Music Index categories (ROCK, JAZZ, ...) using the Music Index function. When the unit is in the LINK ON state, only the stations belonging to the selected category can be scanned by STATION SCAN. (Refer to "Method A of Tuning Preset Stations," page 25 and "Tuning in a Categorized Station," page 27.) Also the sound is equalized according to the equalization curve assigned to the selected category.

SYSTEM POWER → ON

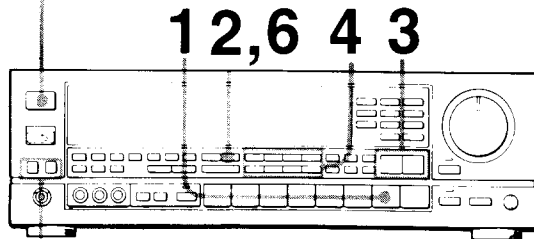

Select SPEAKERS A or B

- 1** Select the function **TUNER**.
- 2** Press **MEMORY INDEX**.
The LINK and the MEMORY indicators will appear.
- 3** Tune in the desired preset station with **STATION SCAN +** or **-**.
- 4** Assign a Music Index to the tuned in station by pressing the corresponding **EQ/MUSIC INDEX CATEGORY** button.
The box-shaped indicator for the selected Music Index will blink.
- 5** Repeat Steps 3 and 4 for all other stations you want to assign a Music Index to.
- 6** Press again **MEMORY INDEX**.
The MEMORY indicator will disappear and the box-shaped indicator will stop blinking.

All preset stations will remain under category OPTION-2
Until you perform the above operation.

Each station can be stored under only one category
If you store an already categorized station under any other category, only the last selected category will be valid.

Channel numbers to be assigned to categorized stations
Serial numbers (1, 2, ...) will be assigned to the stations by category.

The Music Index function cannot be used

- if no stations have been preset (see "Presetting Broadcast Stations," page 24.), or
- when the unit is in the direct tuning mode.

Tuning in a Categorized Station

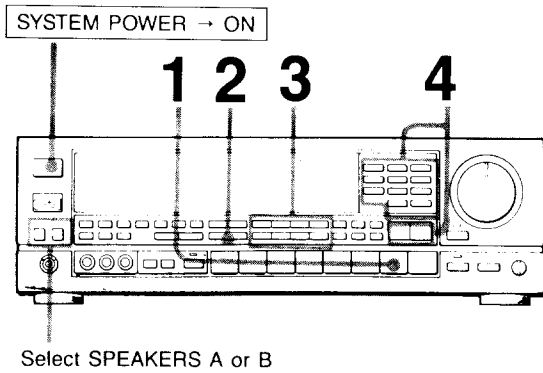

- 1** Select the function **TUNER**.
- 2** If the **LINK** and the **INDEX** indicators are not displayed in the display window, **press PRESET EQ LINK to put the unit in the LINK ON state**. The **LINK** and the **INDEX** indicators will light up, and the Music Index of the present station will be indicated by the box-shaped indicator.
- 3** Press the **EQ/MUSIC INDEX CATEGORY** button for the category you want to listen to.
- 4** Select the desired station with the **STATION SCAN +/-** buttons or by entering its channel number with numeric and **ENTER** buttons.

You cannot put the unit in the LINK ON state when the unit is in the direct tuning mode. To cancel the mode, change the receiving band or press a **STATION SCAN** button.

To listen to the station without any equalization
Press **DEFEAT**.
To use another equalization curve, you have to set the receiver to **LINK OFF**, by pressing the **PRESET EQ LINK**.

When the unit is in the LINK ON state
You cannot tune in any station that has not been memorized under the Music Index Category selected at Step 3.

Using the Graphic Equalizer

You can enjoy a music with a different equalization curve than the ones preset at the factory.

Creating a New Equalization Curve

SYSTEM POWER · ON

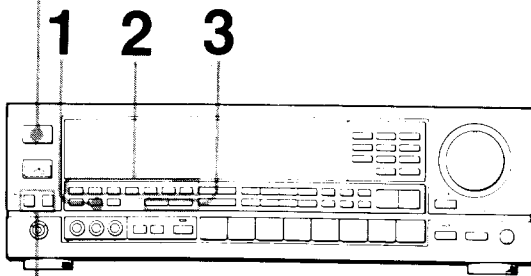

Select SPEAKERS A or B

- 1 Press RTA/EQ.**
This switches the display to the equalizer setting.
- 2 Press the frequency select button for the frequency of which the level you want to raise or lower.**
- 3 Press the LEVEL + (or -) button** to raise (or lower) the level of the selected frequency. (The MANUAL indicator will light up.)
- 4 Repeat Steps 2 and 3 for other frequencies until you obtain the desired equalization curve.**

To restore the RTA (real time analyzer) display, press RTA/EQ.

Adjustable frequency bands and the effect of level adjustment

63 Hz: Lowering the level will cut the ventilation noise of a music hall, hum of electronic instruments, boomy bass, etc.

Raising the level will reinforce the heavy bass part of a pipe organ or add depth to the bass sound.

150 Hz: Boosting or cutting the normal bass.

400 Hz: Increasing or decreasing the power, spaciousness and warmth of the sound.

1 kHz: Providing more presence for vocals, and moving the sound forward or into the background.

2.4 kHz: Lowering the level will reduce stridency, and raising will make the base sound brighter.

6 kHz: Increasing or decreasing the brightness of the sound; for example, raising the level will make the violin sound silky smooth.

14 kHz: Changing the general atmosphere rather than the sound itself.

Raising the level will highlight the delicate quality of instrumental sound, and lowering will reduce high-frequency noise such as the resonant peak of a cartridge, tape hiss, etc.

Memorizing a New Equalization Curve

You can store a created equalization curve into memory under any Music Index Category you select. However, note that this operation will erase the factory-preset equalization curve or the last memorized one under the selected Music Index Category.

SYSTEM POWER → ON

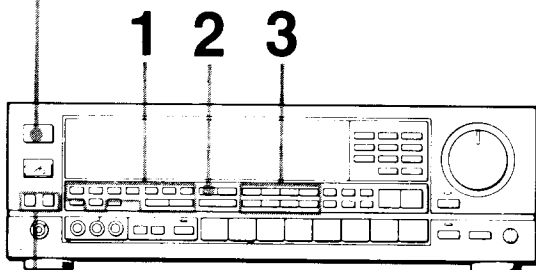

Select SPEAKERS A or B

Before beginning the operation below, make sure that neither DEFEAT indicator nor LINK indicator is lit. If lit, press the DEFEAT and/or PRESET EQ LINK button.

- 1 Create an equalization curve** you want to store.
- 2 Press MEMORY EQ.** The MEMORY indicator will light up for a few seconds.
- 3 Press, while the MEMORY indicator is displayed, the EQ/MUSIC INDEX CATEGORY button** for the category under which you want to store the equalization curve.

Listening to a Music with a Memorized Equalization Curve

SYSTEM POWER → ON

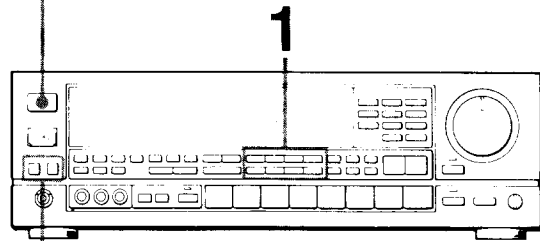

Select SPEAKERS A or B

- 1 Press the desired EQ/MUSIC INDEX CATEGORY button.**
If you have not stored a curve under that category, the factory-preset curve will be called in.

Note

This operation cannot be performed while DEFEAT or LINK indicator is lit.
Press DEFEAT or PRESET EQ LINK to make the indicator go out.

Listening to a Music without Using the Graphic Equalizer Function

SYSTEM POWER → ON

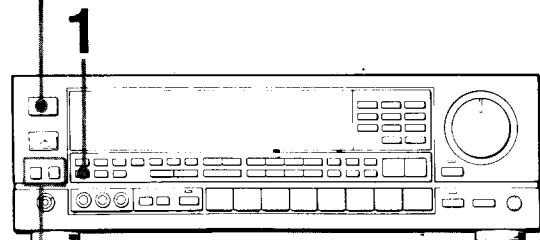

Select SPEAKERS A or B

- 1 Press DEFEAT.**
The Graphic Equalizer control buttons will become ineffective.

To restore the graphic equalizer effect
Press again the DEFEAT button.

To accurately check the highest input (STR-AV1000 only)

Press the PEAK HOLD button.

The real time analyzer display will hold the highest input of each frequency range for several seconds.

Listening to Program Sources Other than Radio Broadcasts

SYSTEM POWER → ON

1

3

Select SPEAKERS A or B

	FUNCTION selector to be pressed
Phono record	PHONO
Compact disc	CD
DAT programs	DAT
Taped Programs	TAPE 1, TAPE 2 MONITOR
Video programs	VIDEO 1, VIDEO 2/CDV, VIDEO 3 (STR-AV1000)

2

Turntable system

CD player

Tape deck

DAT

VCR

CDV player

- 1 Select the program source.
- 2 Start the selected program.
- 3 Adjust the volume.

Receiving FM Simulcast TV Programs

SYSTEM POWER → ON

3

TV tuner or VCR

Monitor TV

2

VIDEO 1 or VIDEO 2 IN

MONITOR VIDEO OUT

1

4 5

Select SPEAKERS A or B

- 1 Select VIDEO 1, VIDEO 2, or VIDEO 3 (STR-AV1000) according to video inputs connected to an equipment to which the VHF antenna is connected.
- 2 Turn on the TV.
- 3 Select the desired program on the TV tuner or the VCR.
- 4 Select TUNER and tune in the FM simulcast TV program on the Receiver.
- 5 Adjust the volume.

Recording on an Audio Tape or DAT

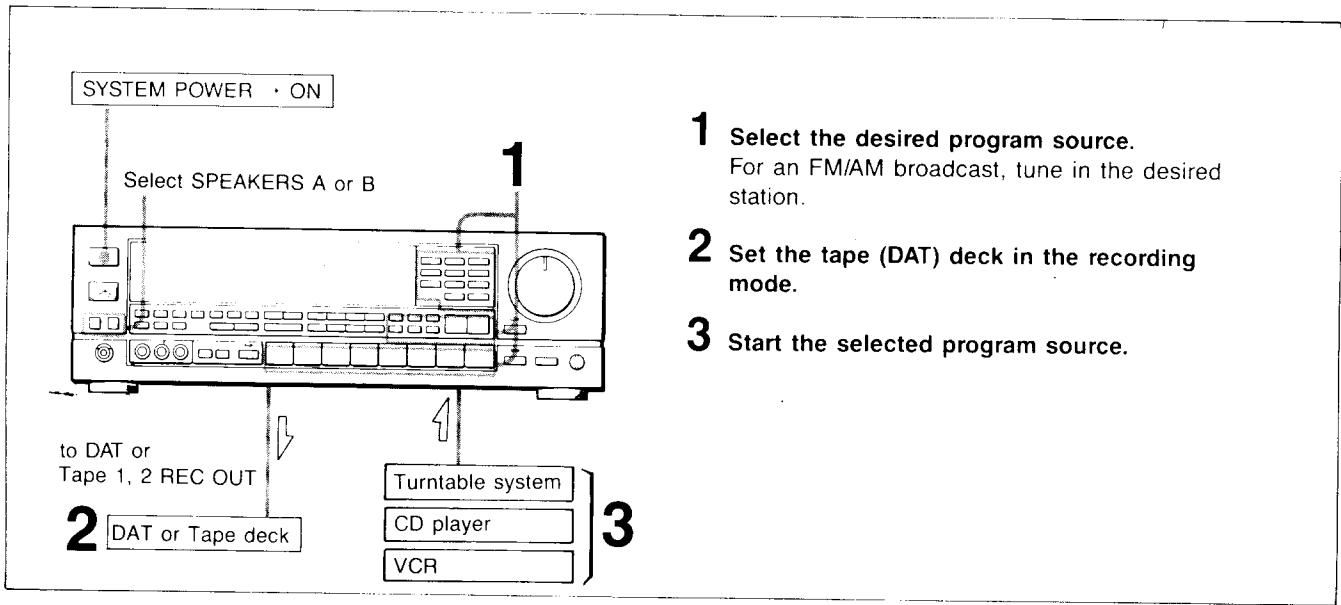

Tape Dubbing

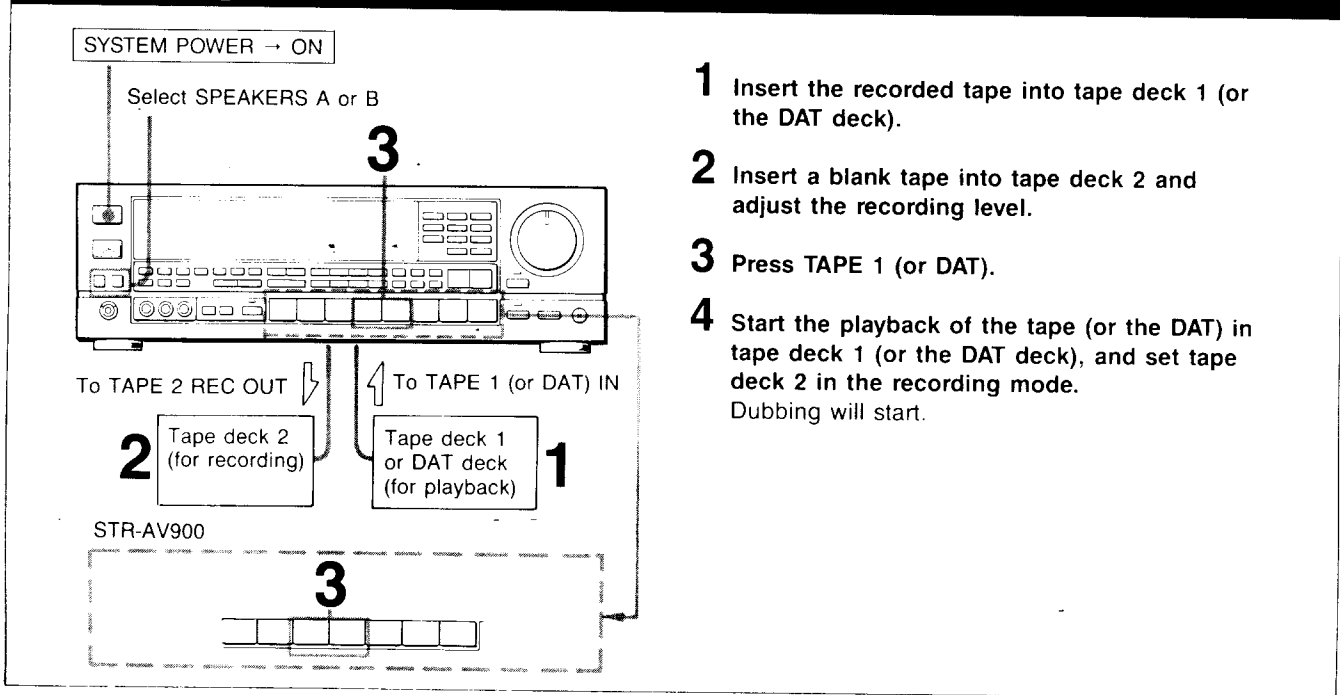

Note on recording

The settings of the VOLUME, SURROUND, BALANCE, SOBSONIC, and graphic equalizer do not have any effect on recording.

Monitoring the recorded sound

If you have connected a tape deck having separate record and playback heads to the TAPE 2 jacks, you can monitor the recording results. While recording or dubbing, press the TAPE 2 MONITOR button. To listen to the source sound again, press the button again.

Note on tape dubbing

Tape dubbing is possible only in the following directions:

From (playback side)	To (recording side)	FUNCTION selector to be pressed
Tape deck connected to TAPE 1 IN	Tape deck connected to TAPE 2 REC OUT	TAPE 1
	DAT deck connected to DAT REC OUT	
DAT deck connected to DAT IN	Tape deck connected to TAPE 1 or 2 REC OUT	DAT

Video Operations

Recording a TV Program on a Video Tape with the STR-AV1000

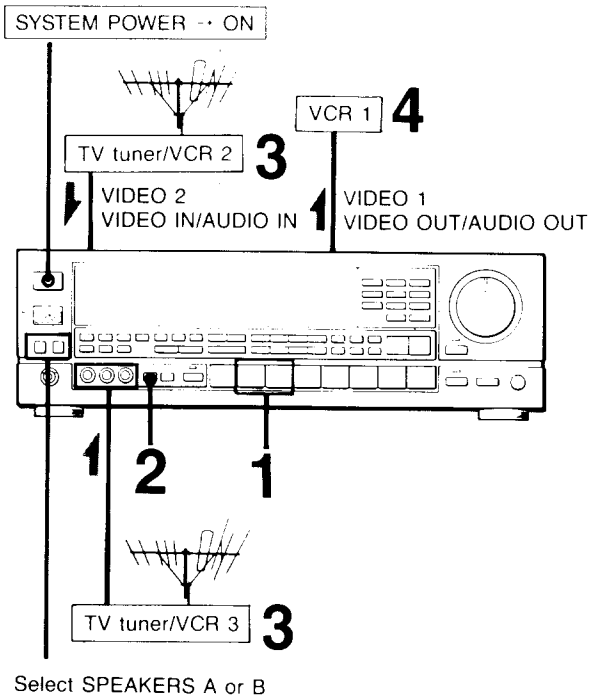

Preparation

- Turn on the unit and the equipment to be used.
- If the AUDIO indicator is lit in the VIDEO EDIT display, press the EDIT AUDIO button to make the indicator go out.

- 1 Press the function selector VIDEO 2/CDV or VIDEO 3 according to the video inputs connected to an equipment to which the TV antenna is connected.
- 2 Make 2▶1 or 3▶1 appear in the VIDEO EDIT display area using the EDIT VIDEO button.
2▶1: When you have selected VIDEO 2/CDV at step 1.
3▶1: When you have selected VIDEO 3 at step 1.
- 3 Select the desired TV program on the TV tuner (VCR 2 or 3).
- 4 Set VCR 1 to the recording mode.

Recording a TV Program on a Video Tape with the STR-AV900

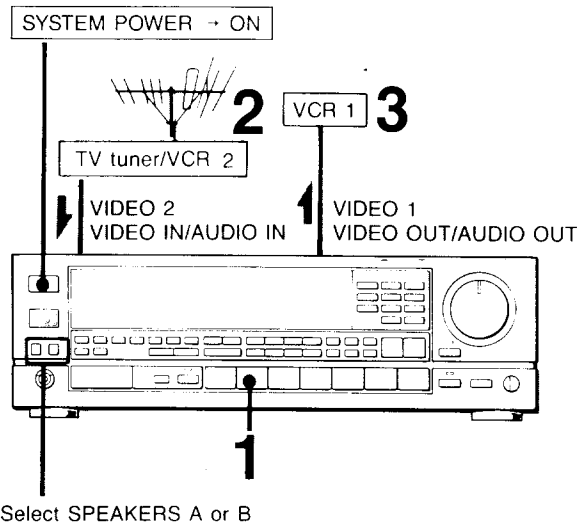

Preparation

- Turn on the unit and the equipment to be used.
- If the AUDIO indicator is lit in the display window, press the EDIT AUDIO button to make the indicator go out.

- 1 Press the function selector VIDEO 2/CDV.
- 2 Select the desired TV program on the VCR 2.
- 3 Set VCR 1 to the recording mode.

Note

The VOLUME, BALANCE, SURROUND, SUBSONIC and graphic equalizer settings do not have any effect on the recording.

Video Tape Editing with the STR-AV1000

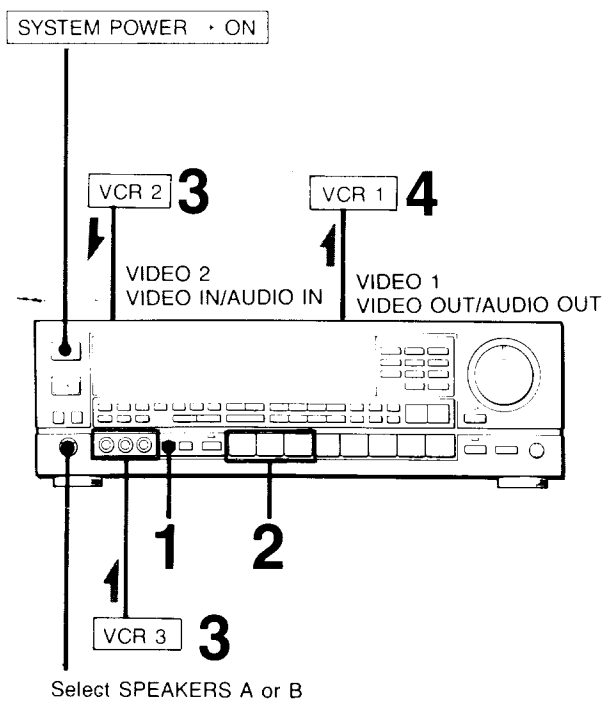

Preparation

- Turn on the unit and the equipment to be used.
- If the AUDIO indicator is lit in the VIDEO EDIT display, press the EDIT AUDIO button to make the indicator go out.

- 1** Select the playback-side VCR using the EDIT VIDEO button.
2▶1: for VCR 2.
3▶1: for VCR 3.
2▶1 or 3▶1 will be indicated in the VIDEO EDIT display area.
- 2** Select the input video signal source for the monitor TV with the function selectors.
VIDEO 1: for VCR 1.
VIDEO 2/CDV: for VCR 2.
VIDEO 3: for VCR 3.
- 3** Set the playback-side VCR to the playback mode.
- 4** Set VCR 1 to the recording mode.
Editing will begin.

Video Tape Editing with the STR-AV900

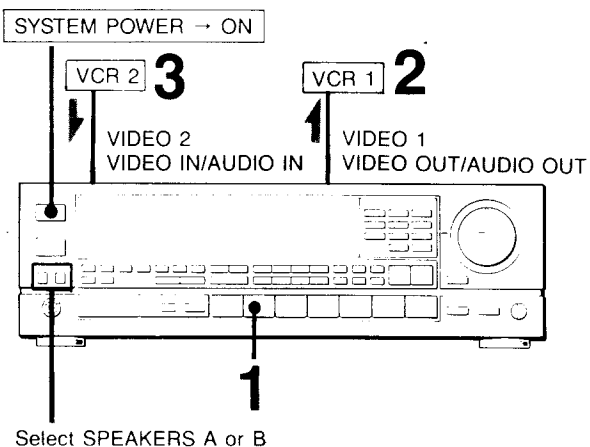

Preparation

- Turn on the unit and the equipment to be used.
- If the AUDIO indicator is lit in the display window, press the EDIT AUDIO button to make the indicator go out.

- 1** Press VIDEO 2/CDV.
- 2** Set VCR 1 to the recording mode.
- 3** Set VCR 2 to the playback mode.

To switch the playback-side VCR during editing with the STR-AV1000

Press EDIT VIDEO. Each time you press the button, the playback-side VCR switches from VCR 2 or 3 to VCR 3 or 2.

To view the other video source(s) on the monitor TV during editing

Press the appropriate FUNCTION selector:

- VIDEO 1, VIDEO 2/CDV, or VIDEO 3 with the STR-AV1000
- VIDEO 1 or VIDEO 2/CDV with the STR-AV900.

Listening to an audio program during video tape editing

1. Press the appropriate FUNCTION selector.
2. Start the selected audio program source.

Video Operations

Adding the Desired Sound on a Video Tape during Editing

During video tape editing, you can add the desired sound on the recording-side video tape from various audio program sources.

Audio Dubbing during Video Tape Editing with the STR-AV1000

1 Select the playback side VCR with the **EDIT VIDEO** button.
 2▶1 or 3▶1 will appear in the VIDEO EDIT display area.
 2▶1: for VCR 2
 3▶1: for VCR 3

2 Insert a recorded video tape into the playback-side VCR and set the VCR to the playback mode.

3 At the point where audio dubbing is to start, press the **PAUSE** button on the playback-side VCR.

4 Press **EDIT AUDIO**.

5 Select the audio program source with the appropriate function selector.

6 Release the **PAUSE** mode of the playback-side VCR and set VCR 1 to the recording mode.

7 Start the selected audio program source. Audio dubbing will start.

Audio Dubbing during Video Tape Editing with the STR-AV900

1 Press **VIDEO2/CDV**.

2 Insert a recorded video tape into VCR 2 and set the VCR to the playback mode.

3 At the point where audio dubbing is to start, press the **PAUSE** button on VCR 2.

4 Press **EDIT AUDIO**.

5 Select the audio program source with the appropriate function selector.

6 Release the **PAUSE** mode of VCR 2 and set VCR 1 to the recording mode.

7 Start the selected audio program source. Audio dubbing will start.

Specifications

AUDIO POWER SPECIFICATIONS

POWER OUTPUT AND TOTAL HARMONIC DISTORTION:

With 8-ohm load, both channels driven, from 20-20,000 Hz, rated 120 watts (STR-AV1000) or 100 watts (STR-AV900) per channel minimum RMS power, with no more than 0.008% (STR-AV1000) or 0.03% (STR-AV900) total harmonic distortion from 250 milliwatts to rated output.

Other Specifications

Amplifier section

Dynamic power output

STR-AV1000

195 watts + 195 watts (8 ohms, at 1 kHz IHF)

250 watts + 250 watts (4 ohms, at 1 kHz IHF)

STR-AV900

140 watts + 140 watts (8 ohms, at 1 kHz IHF)

190 watts + 190 watts (4 ohms, at 1 kHz IHF)

Harmonic distortion

STR-AV1000: Less than 0.008 % at rated output

STR-AV900: Less than 0.03 % at rated output

Intermodulation (IM) distortion

STR-AV1000: Less than 0.008% at rated output

STR-AV900: Less than 0.03 % at rated output

Frequency response

PHONO:RIAA equalization curve ± 0.5 dB

CD, DAT, TAPE 1,2 } 5 Hz - 80 kHz ± 0 dB

VIDEO 1, 2/CDV, 3 }

Residual noise Less than 70 μ V (8 ohms, network A)

Damping factor 50 (8 ohms, 1 kHz)

Inputs

	Sensitivity	Impedance	S/N
PHONO MM	2.5 mV	50 kilohms	87 dB 79dB* (A, 2.5mV)
DAT, CD, VIDEO 1,2,3 TAPE 1,2	150 mV	50 kilohms	105dB 86 dB* (A,150mV)

*78 IHF

Outputs

DAT OUT, REC OUT 1,2, VIDEO 1

Voltage 150 mV

Impedance 10 kilohms

SPEAKER A, B

Accepts speakers of 8-16 ohms.

HEADPHONES

Accepts high and low impedance headphones

Subsonic filter 6 dB/oct. attenuation below 15 Hz

Muting -20 dB

Graphic Equalizer

± 10 dB at 63 Hz, 150 Hz, 400 Hz, 1 kHz,

2.4 kHz, 6 kHz, and 14 kHz

Video section

Inputs VIDEO 1, 2, 3: 1Vp-p, 75 ohms

Outputs VIDEO 1. MONITOR: 1Vp-p, 75 ohms

FM tuner section

Frequency range 87.5 MHz - 107.9 MHz

Antenna terminals 75 ohms, coaxial

Sensitivity at 50 dB 18.3 dBf, 4.5 μ V (mono)

38.3 dBf, 45 μ V (stereo)

Usable sensitivity 11.2 dBf, 2 μ V (IHF)

Single-to-noise ratio 82 dB (mono), 76 dB (stereo)

Harmonic distortion 0.1% (mono), 0.2% (stereo) at 1 kHz

IM distortion 0.1% (mono), 0.2% (stereo)

Separation 45 dB at 1 kHz

Frequency response 30 Hz - 15 kHz ± 0.5 dB

Selectivity 60 dB at 400 kHz

Capture ratio 1.2 dB

AM suppression ratio 54 dB

Image response ratio 80 dB

IF response ratio 90 dB

Spurious response ratio 100 dB

RF Intermodulation 65 dB (800 kHz)

Auto tuning threshold LOW 30 dBf, HIGH 50 dBf

AM tuning section

Frequency range 530 - 1,610 kHz (with 10 kHz interval)

531 - 1,602 kHz (with 9 kHz interval)

Antenna Loop antenna

Usable sensitivity 50 dB/m (at 1,000 kHz or 999 kHz)

Signal-to-noise ratio 54 dB (at 50 mV/m)

Harmonic distortion 0.3% (50 mV/m, 400 Hz)

Selectivity 35 dB (9 kHz), 40 dB (10 kHz)

Auto tuning threshold 55 dB

General

System

Tuner section: PLL quartz-locked digital synthesizer system

Preamplifier section: low-noise NF type equalizer

Power amplifier section: pure complementary SEPP

Power requirements 120V AC, 60Hz

Power consumption

USA model

STR-AV1000: 210 watts

STR-AV900: 170 watts

Canadian model

STR-AV1000: 450 VA

STR-AV900: 380 VA

AC outlets

Two switched, total 100W

Dimensions

Approx. 430x130x356mm (w/h/d)

(17x5 $\frac{1}{8}$ x14 $\frac{1}{8}$ inches)

Including projecting parts and controls

Weight

STR-AV1000 Approx. 8.3 kg (18 lb 5 oz) net

STR-AV900 Approx. 7.3 kg (16 lb 2 oz) net

Accessories supplied

FM ribbon antenna (1)

AM loop antenna (1)

Remote Commander

(1, RM-P101 for STR-AV1000,

RM-U80 for STR-AV900)

External antenna connector (1)

Sony Batteries SUM-3 (NS) (4 for RM-P101

Remote Commander and 2 for RM-U80

Remote Commander)

Troubleshooting Guide

Before proceeding through the check list below, examine the connections and the procedures outlined in the manual.

Should any problem persist after you have checked the following items, consult your nearest Sony dealer.

Radio Broadcast Reception		
Problem	Cause	Solution
Automatic SEARCH operation cannot be performed.	The unit is in the PRESET EQ LINK mode. (The LINK indicator is lit.)	Press PRESET EQ LINK to make the LINK indicator go out.
No FM station can be located by automatic SEARCH operation.	The signal strength of the stations is too weak.	Press FM TUNING LEVEL to set to LOW level.
The STEREO indicator flickers or does not appear when receiving stereo programs.	A very weak FM station or a noisy FM program is received.	Adjust the antenna or connect an external FM antenna.
		Press the FM MODE button to set to MONO mode.
No AM station can be located by automatic SEARCH operation.	The AM tuning interval is set incorrectly.	Change the tuning interval according to the AM frequency allocation system of your country. (See page 23.)
	The signal strength of the stations is too weak for automatic SEARCH.	Adjust the antenna. Directly tune in the stations. (See page 23.)
No stations can be tuned in by STATION SCAN operation.	No stations have been preset.	Preset the stations by automatic SEARCH operation. (See page 24.)

Graphic Equalizer and Music Index Functions		
Problem	Cause	Solution
When the function TUNER is selected, you cannot call in a factory-preset or user-memorized equalization curve by pressing the corresponding EQ/MUSIC INDEX CATEGORY button.	Although no stations have been stored under that category, the unit is in the LINK ON state (the LINK indicator is lit.)	Press PRESET EQ LINK to make the LINK indicator disappear.
		Store at least one station under that category.
Equalization curve adjustment is impossible.	The graphic equalizer is in the DEFEAT mode (the DEFEAT indicator is lit).	Press DEFEAT to make the DEFEAT indicator disappear.
	The unit is in the LINK ON state (the LINK indicator is lit).	Press PRESET EQ LINK to the LINK indicator disappear.

Sound		
Problem	Cause	Solution
No sound is heard even if you adjust VOLUME.	The speaker or program source equipment is not connected correctly.	Connect the equipment correctly.
	The SPEAKERS selectors are not set correctly.	Set the selectors correctly.
	The TAPE 2 MONITOR button has been pressed for a program source other than tape deck 2. (The indicator is lit.)	Press the button to disengage.
	A wrong FUNCTION selector has been pressed.	Check the FREQUENCY/FUNCTION display area, and press the correct FUNCTION selector.
	The function switch on the VCR is not set correctly.	Check and set it correctly.
Sound is heard only at a very low volume.	The MUTING button has been pressed. (The MUTING indicator is lit.)	Press the button to disengage.
One channel does not transmit audio, or the volume from the left and right speakers is unbalanced.	The BALANCE control is not set appropriately.	Adjust the BALANCE control.
	The speaker or program source is not connected correctly.	Check and properly connect the equipment.
There is an abrupt loss of sound from one or both of the speakers, and the PROTECTOR indicator flickers in the display window.	A short-circuit problem activates the protective circuit.	Turn off the unit, eliminate the short-circuit problem and turn on the power again. If there is no short-circuit problem, consult your nearest Sony dealer.
Sound transmitted from the speakers is reversed.	The speakers are not connected correctly.	Connect the right speaker to the R SPEAKER terminals and the left speaker to the L SPEAKER terminals.
There is lack of bass sound or the instrument position is obscure.	The +/– connection of the speaker is reversed.	Connect the speaker with the correct phase.
Severe hum or noise is heard.	The connecting cords are not shielded type.	Use shielded type cords.
	A transformer, motor, TV or fluorescent light affects the connecting cords.	Place the connecting cords in a location away from a transformer or motor, and at least 3 meters (10 feet) from a TV set or a fluorescent light.
	The audio components are too close to a TV set.	If both are used at the same time, separate the TV from the audio components.
	The unit is not grounded.	Connect the ground wire to the antenna ground terminal.
	The connections are loose.	Make secure connections.
	The plugs and jacks are dirty.	Wipe the plugs and jacks with a cloth lightly dampened with alcohol.

Remote Commander		
Problem	Cause	Solution
The remote commander will not operate.	The batteries are exhausted.	Replace the batteries with new ones.
	The commander head is not pointed toward the unit's front.	Point the commander head toward the receiver.
	There is an object between the commander and the receiver.	Remove the object.

Quick Reference

When you operate the unit consulting this Quick Reference, make sure that the unit and the various audio/video equipments are properly connected. (Refer to the Overall Connection Diagram given on page 6.)

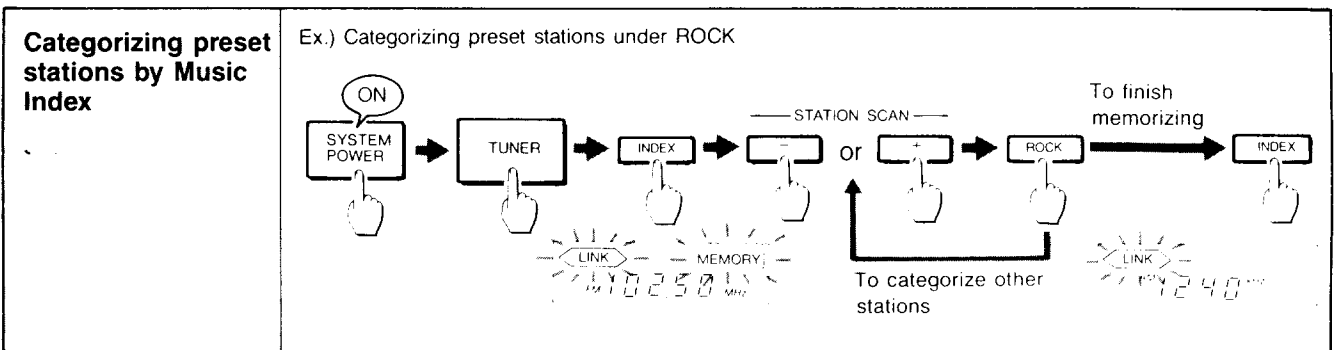
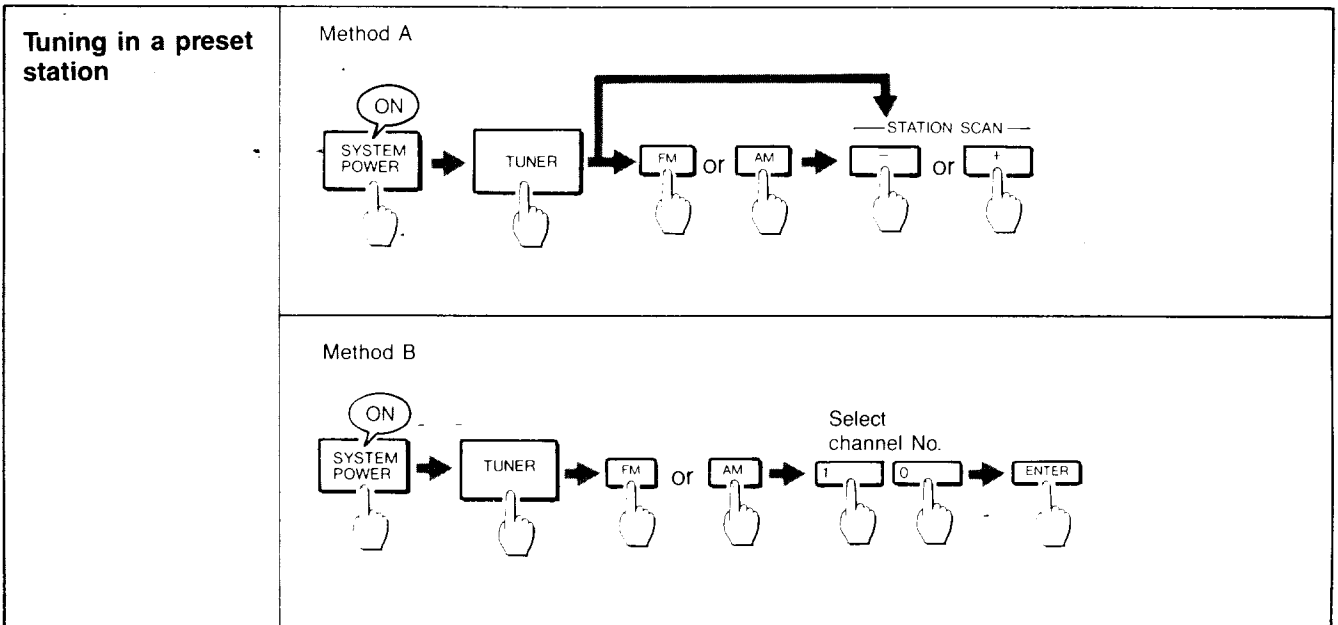
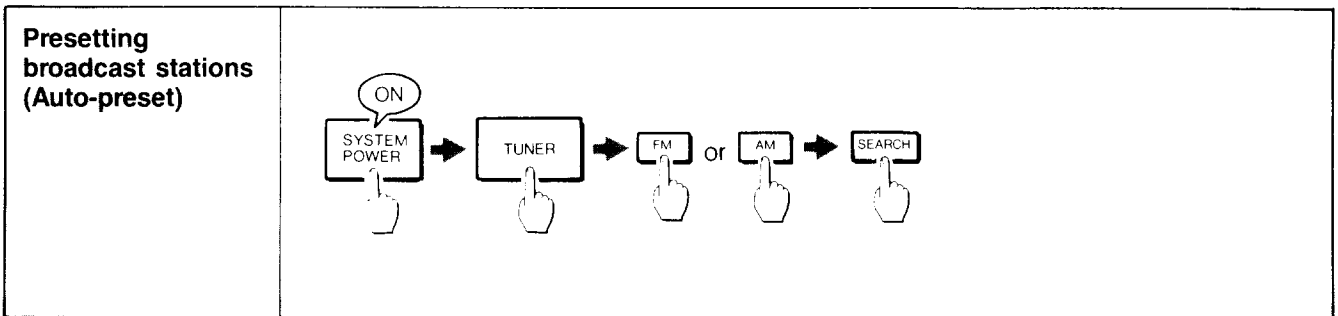
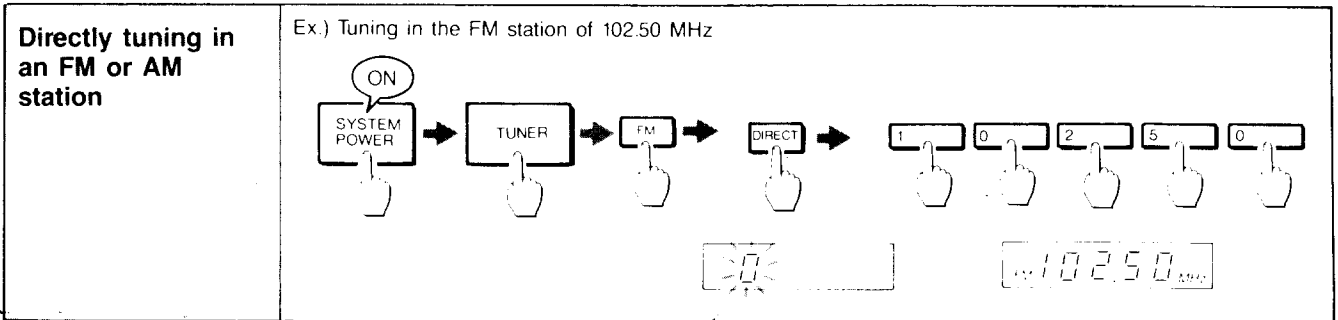

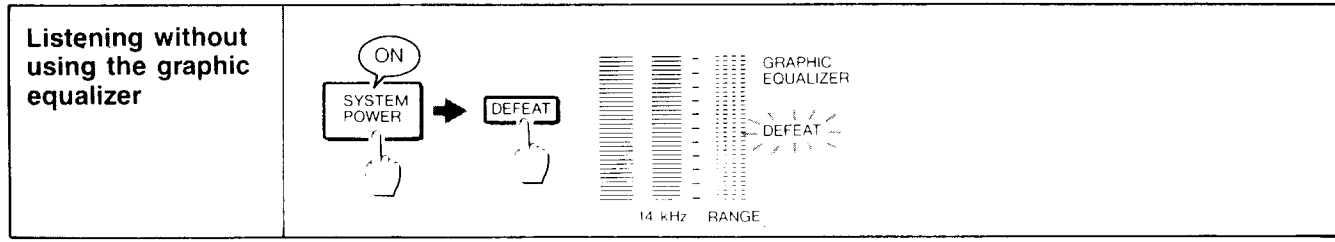
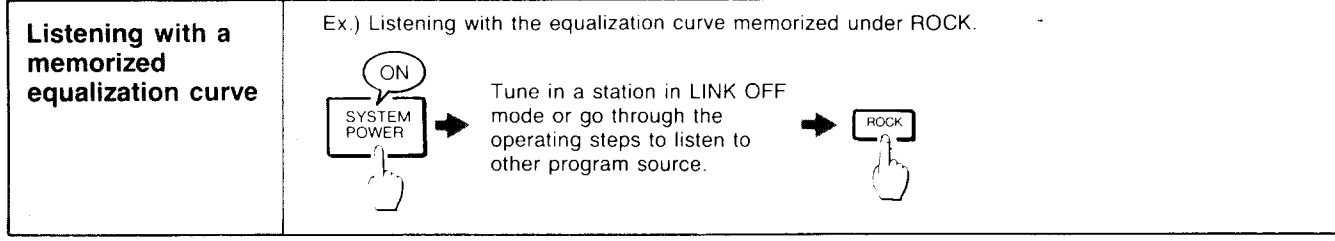
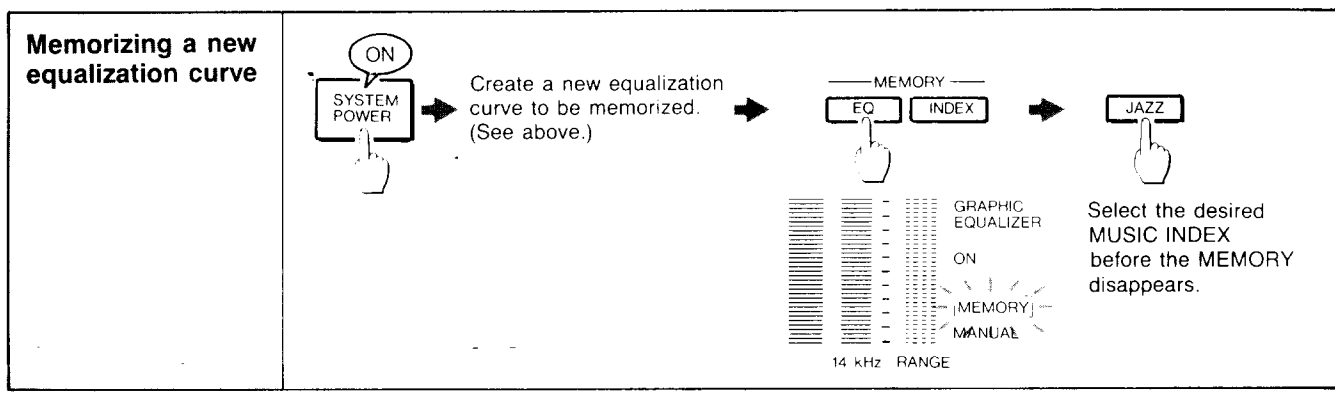
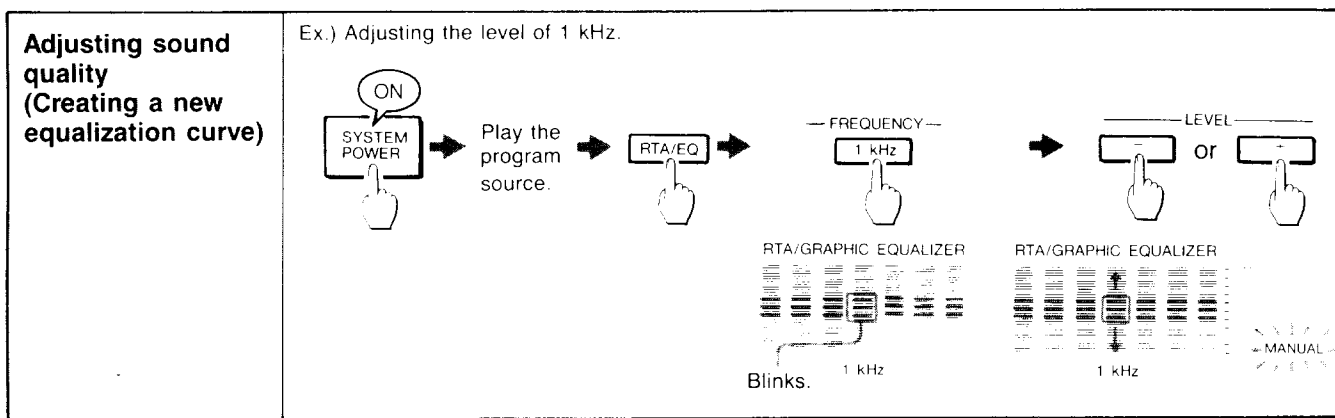
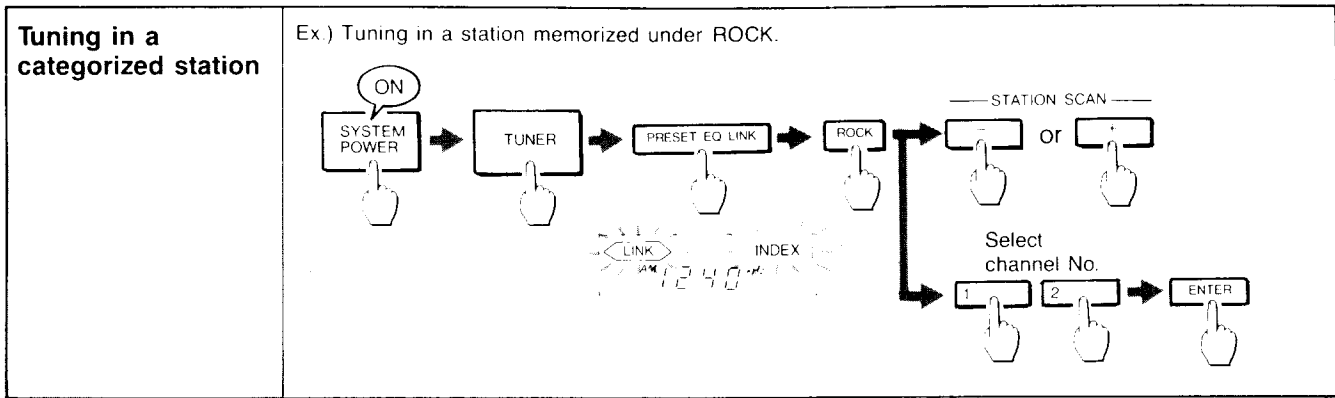

Quick Reference

Video Operations with the STR-AV1000

Recording a TV program on a video tape

Ex.) When the VHF antenna or CATV cable is connected to the TV tuner or VCR connected to the VIDEO 2 inputs.

Turn on the equipment to be used.

If the AUDIO indicator is lit

Select the input video source for monitor TV.

Make 2 ▶ 1 appear.

MONITOR VIDEO EDIT
VIDEO-2 VIDEO-2▶1
VIDEO 2

Set VCR 1 to the recording mode. ← Select the desired TV program.

Video tape editing

Turn on the equipment to be used.

If the AUDIO indicator is lit

Select the monitor TV input video signal source.

VIDEO 2/CDV or VIDEO 3

Select the playback-side VCR (2 ▶ 1 or 3 ▶ 1).

Set VCR 1 to the recording mode. ← Set the playback-side VCR to the playback mode.

Audio dubbing during video tape editing

Start video tape editing.

At the desired point, set the playback-side VCR and VCR 1 to pause.

Select the desired audio program source.

CD

Start the audio program source. ← Release pause on both playback-side VCR and VCR 1.

Video Operations with the STR-AV900

